



bravo180S



**BRAVO 180S SERIES COMPUTER
CROP SPRAYING**





CE



46718XXXX

Software rel. 1.6.x

INSTALLATION, USE AND MAINTENANCE



	= Generic danger
	= Warning
	= Displayed error message
	= Menu visible only with specific settings: to view it, enable one of the indicated options.
	= Page / paragraph reference

	= Indications for crop SPRAYERS
	= Indications for multi-row SPRAYERS
	= Indications for ORCHARD SPRAYERS

01361883418
Cleveland Alliances



• Legend of symbols.....	2	12 User setting.....	25
• Manual foreword and use.....	4	12.1 Jobs setup	26
• Manual use modes	4	12.2 Nozzle data	27
• Limitations	4	12.3 Minimum regulation pressure	28
• Responsibility	4	12.4 Wheel selection	28
1 Product description.....	5	12.5 Minimum speed	28
2 Bravo DSB.....	5	12.6 Rate correction.....	28
3 Risks and protections before assembly.....	5	12.7 Level correction	29
4 Intended use	5	12.8 Display contrast	29
5 Precautions	5	12.9 Test device	29
6 Package content	6	12.10 Totalizers.....	30
7 Position on farming machine	7	12.11 Settings manag.....	30
7.1 System recommended composition	7	13 Use.....	31
7.2 Computer positioning.....	9	13.1 Display	31
7.3 Bracket fixing	10	13.2 Controls on computer.....	31
7.4 Control unit position	10	13.2.1 Keys to check the computer and the spraying phases	31
7.5 Hydraulic unit positioning.....	10	13.2.2 Operating switches for control unit valves.....	31
8 Computer connection to the farming machine.....	11	13.2.3 Operating switches for hydraulic valves.....	31
8.1 General precautions for a correct harness position	11	14 Treatment preliminary settings	32
8.2 Power supply connection	12	14.1 Selecting the job program (for automatic control only).....	32
9 Harness connection to the control unit, the hydraulic unit and the available functions.....	13	14.2 Counters reset	32
9.1 Multicore cable connection	13	14.3 Application rate regulation	33
9.2 Control unit valve connection.....	13	14.3.1 Automatic operation (DEFAULT).....	33
9.3 Hydraulic valve connection	14	14.3.2 Manual operation.....	33
9.4 Connection of sensors and other available functions.....	15	14.4 Automatic closure of the main valve (through SKIPPER).....	33
9.5 Pen drive.....	15	14.5 Output menu	34
10 Setup.....	16	14.5.1 Tank filling	35
10.1 Computer switching on/off.....	16	15 Maintenance / diagnostics / repairs.....	36
10.2 Use of keys for setup	17	15.1 Operation errors.....	36
11 Advanced setup	18	15.2 Troubleshooting.....	37
11.1 Tests and checks before programming	18	15.3 Cleaning rules.....	37
11.2 Language.....	19	16 Technical data.....	38
11.3 Units of measur.....	19	16.1 Computer technical data	39
11.4 No. of sections	19	17 End of life disposal.....	40
11.5 Total boom width.....	19	18 Guarantee terms	40
11.6 Variable rate.....	19		
11.7 Speed sensor.....	20		
11.8 Valves	21		
11.9 Flowmeter.....	21		
11.10 Flowmeter constant.....	21		
11.11 Pressure sensor	22		
11.12 Flow calculation	22		
11.13 Pressure calculation	22		
11.14 Nozzle quantity	22		
11.15 Tank source	22		
11.16 Tank setup	23		
11.17 Spraying Menu.....	24		



• **MANUAL FOREWORD AND USE**

This manual provides instructions to assemble, connect and set the computers of the BRAVO 180S family. Any other information is provided in specific sheets to be used exclusively by the installer, containing specific information of each computer model.

• **MANUAL USE MODES**

The section of this manual dedicated to the installation contains information for installers. For this reason we have used technical terms without providing explanations which would be necessary for end users only.

THE INSTALLATION MUST BE CARRIED OUT BY AUTHORISED AND SKILLED PERSONNEL ONLY. THE MANUFACTURER IS NOT RESPONSIBLE FOR ANY OPERATION SPECIFIED IN THIS MANUAL CARRIED OUT BY UNAUTHORISED OR UNSKILLED PERSONNEL.

• **LIMITATIONS**

The descriptions of the assembly phases refer to a "general" computer, so specific models will not be mentioned, unless a certain installation procedure concerns exclusively one computer type.

• **RESPONSIBILITY**

The installer must carry out workmanlike installations and ensure to the end user the perfect operation of the whole system both with ARAG components only and other brands' components.

ARAG always recommends using its components to install control systems.

The installer will be held responsible for any malfunction if he decides to use other brands' components even without actually changing the system parts or harness.

The compatibility check with components and accessories of other manufacturers shall be carried out by the installer.

If the computer or the ARAG components installed together with other brands' components get damaged because of what stated above, no direct or indirect warranty will be provided.



1 PRODUCT DESCRIPTION

The device you have purchased is a computer which, when connected to a valve or suitable control unit, makes it possible to control all phases of treatment in agricultural applications directly from the cabin of the farming machine it is installed in.

These computers can be connected to different sensor types.

The computer is directly connected to the system by means of two cables connected to the hydraulic and control unit valves and the sensors. In the cabin you find all controls necessary to manage the system ensuring great safety during the job.

The BRAVO 18x computer display allows the operator to constantly monitor all data of the current operations, such as vehicle speed, sprayed fluid quantity, the whole sprayed area and so on.

2 BRAVO DSB

ARAG has designed and manufactured a diagnostics system for Bravo series computers and the systems they may be connected to. BRAVO DSB (code 467003) provides reliable diagnostics of computer, control unit or the whole system troubleshooting any potential problems experienced with the BRAVO DSB system.

3 RISKS AND PROTECTIONS BEFORE ASSEMBLY

All installation works must be done with battery disconnected, using suitable tools and any individual protection equipment deemed necessary.

 Use ONLY clean water for treatment tests and simulations: using chemicals during simulated treatment runs can seriously injure persons in the vicinity.

4 INTENDED USE

 This device is designed to work on agricultural machinery for spraying and crop spraying applications. The machine is designed and built in compliance with UNI EN ISO 14982 standard (Electromagnetic compatibility - Forestry and farming machines), harmonized with 2004/108/EC Directive.

5 PRECAUTIONS

-  • Do not aim water jets at the equipment.
• Do not use solvents or fuel to clean the case outer surface.
• Do not clean equipment with direct water jets.
• Comply with the specified power voltage (12 VDC).
• In case of voltaic arc welding, remove connectors from BRAVO and disconnect the power cables.
• Only use ARAG genuine spare parts and accessories.



6 PACKAGE CONTENT

The table below indicates the components that you will find in the BRAVO computer package:

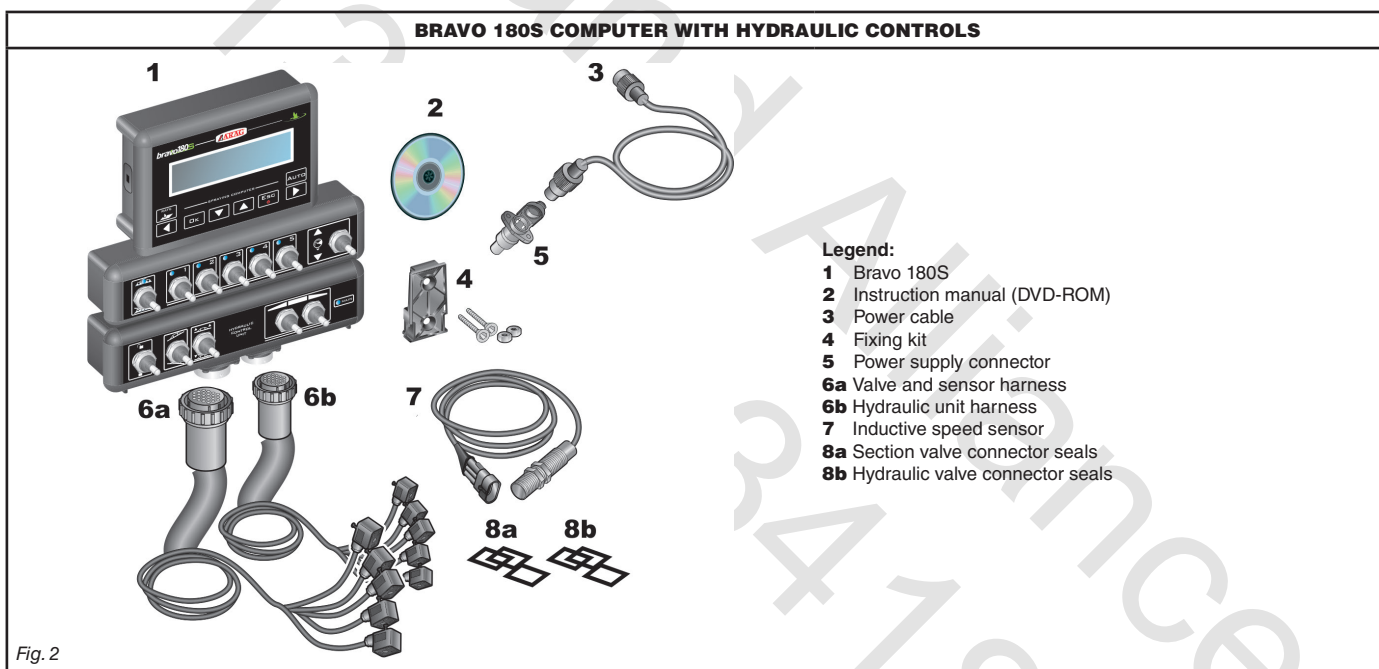
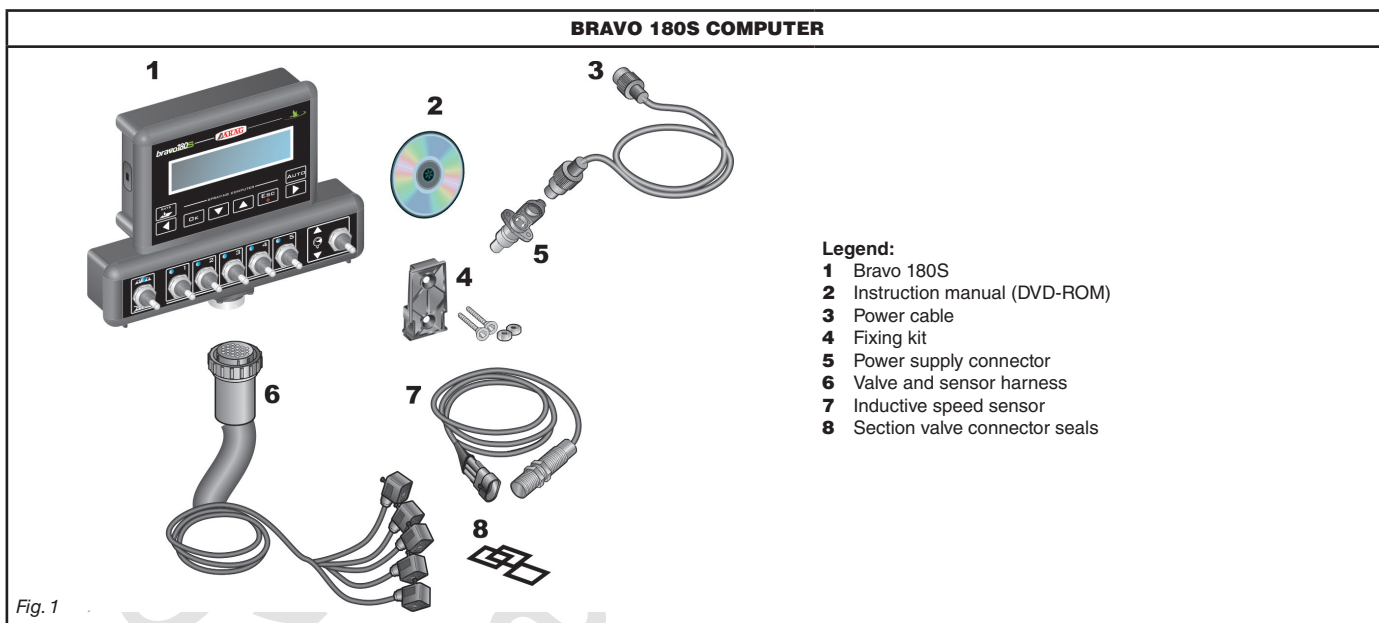



7 POSITION ON FARMING MACHINE

7.1 System recommended composition

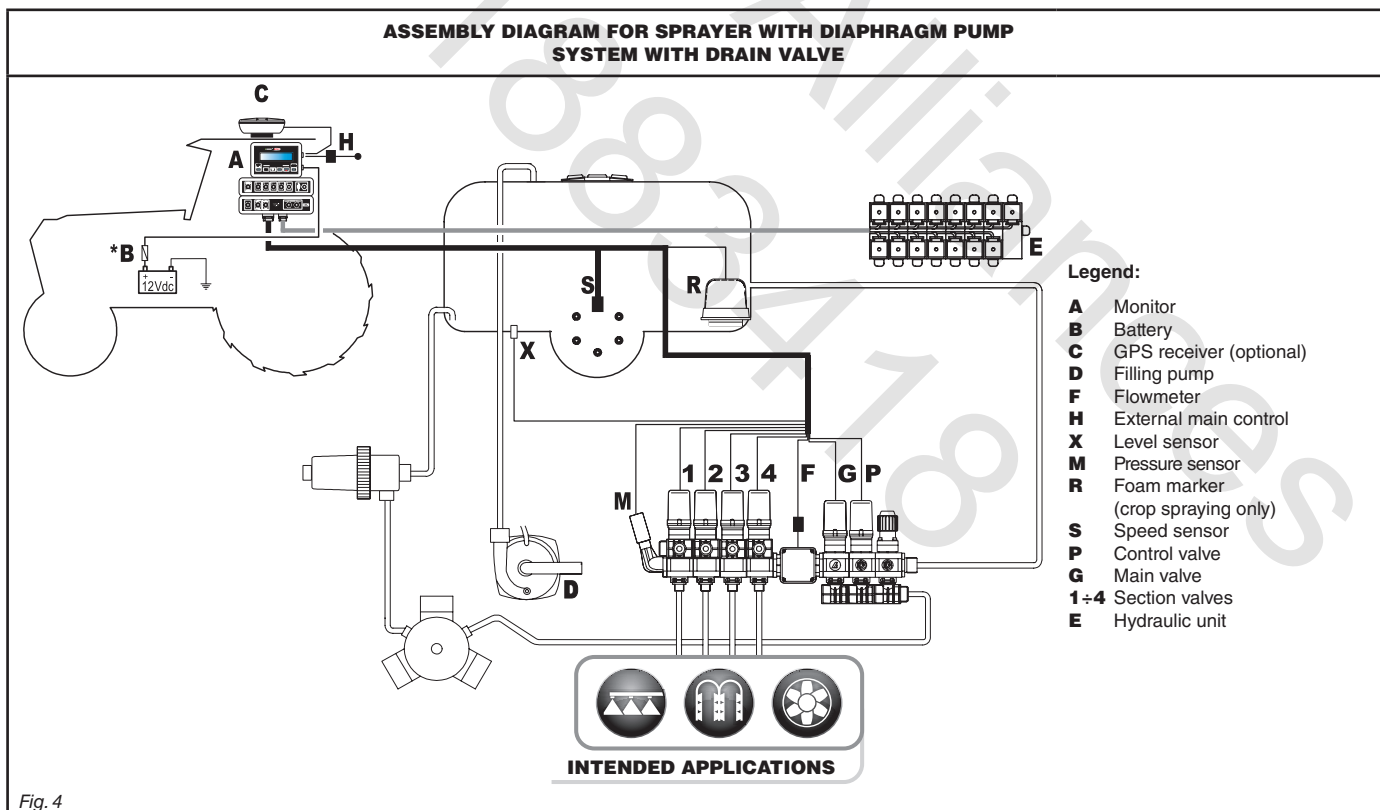
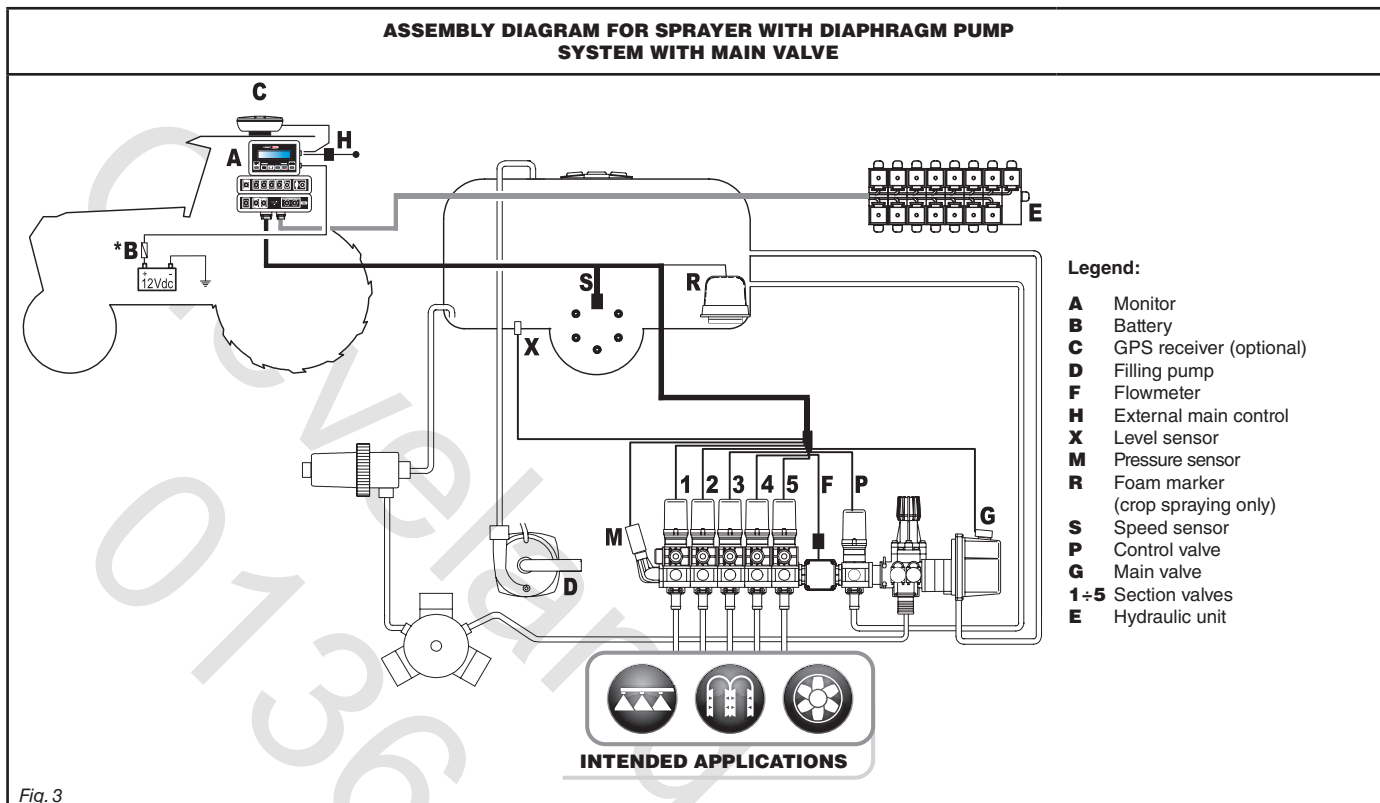

The computer must be directly connected to the farming machine battery.
 * Do not connect the computer to key-operated switch (15/54).



ASSEMBLY DIAGRAM FOR SPRAYER WITH CENTRIFUGAL PUMP

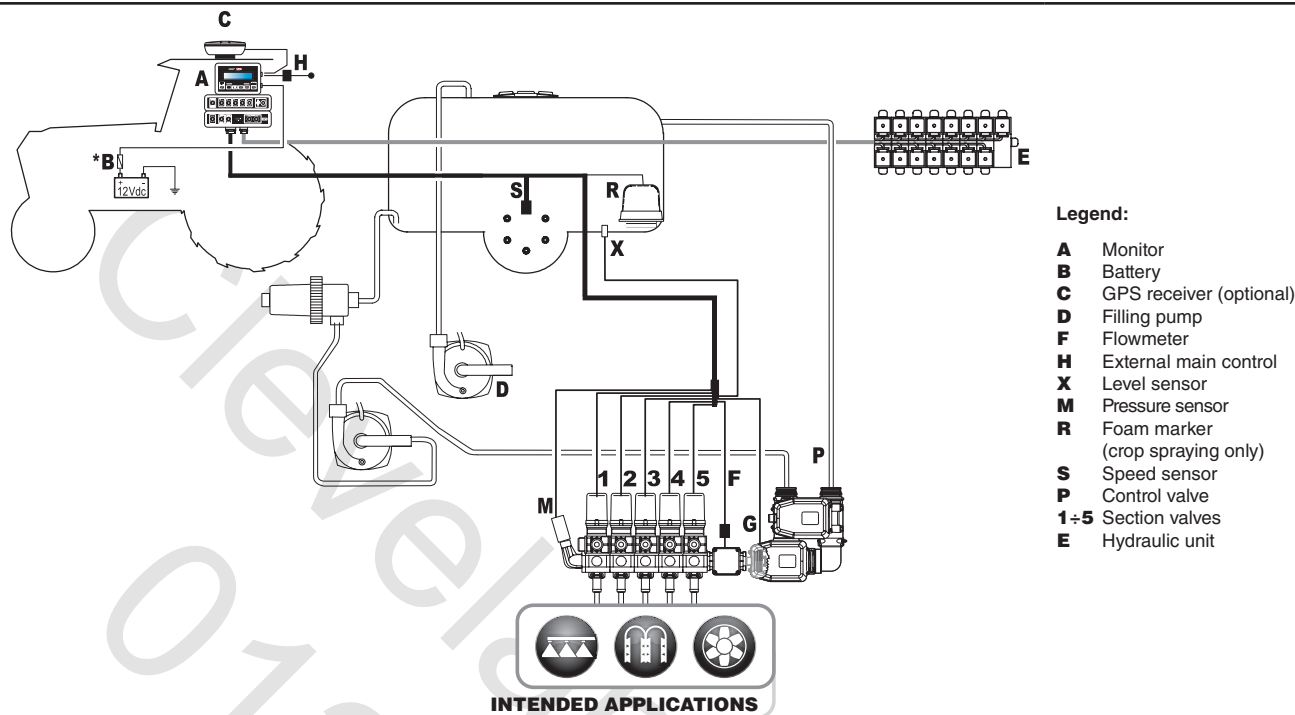

Fig. 5



The computer must be directly connected to the farming machine battery.
* Do not connect the computer to key-operated switch (15/54).



7.2 Computer positioning

The BRAVO 180S series computer must be placed in the control cabin of the farming machine. Observe the following precautions:

- Do NOT install the monitor in areas where it would be subjected to excessive vibrations or shocks, to prevent any damage or accidental use of the control keys;
- Install the device in a visible position within easy reach by hand; bear in mind that the monitor should not obstruct the operator's freedom of movement or block his view.

Consider all necessary connections of the computer, the cable length, and make sure there is enough space for connectors and cables.

An identification symbol is located next to each connector to indicate its function. For any reference to the system configuration read par. 7.1 System recommended composition.

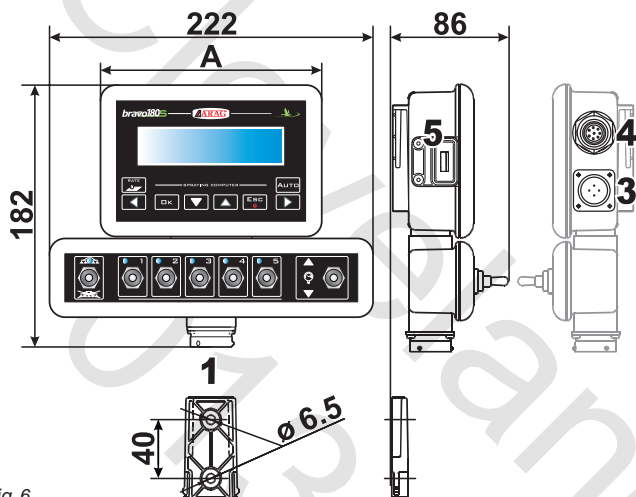

Fig. 6

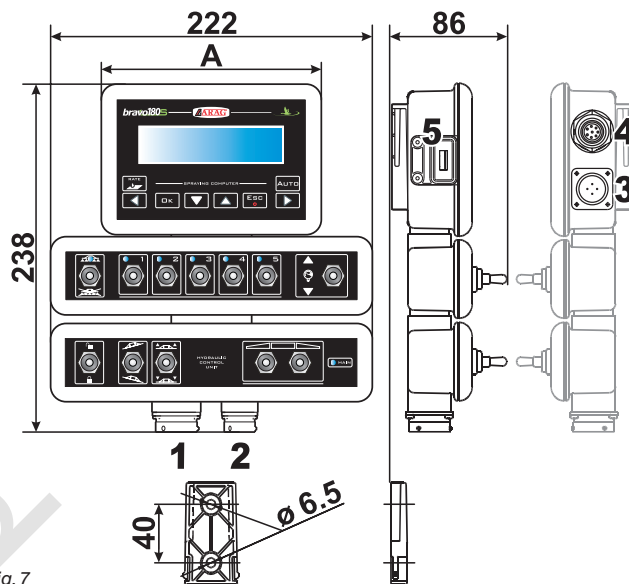

Fig. 7

ITEM	CONNECTION POINTS
1	Control unit and sensors
2	Hydraulic unit
3	Power supply
4	Auxiliary connections
5	USB

SECTIONS	MASTER	PRESSURE	WIDTH A (mm)
--	•	•	152
2	•	•	152
3	•	•	152
4	•	•	222
5	•	•	222
7	•	•	268



7.3 Bracket fixing

The monitor must be mounted after having fixed the bracket at the desired location (the previous paragraph shows the bracket drilling template). The bracket must be slid out of the monitor seat (A, Fig. 8) and fixed using the supplied screws (B). Make sure the bracket is securely mounted, fit the monitor on it, and push it until it locks in place (C).

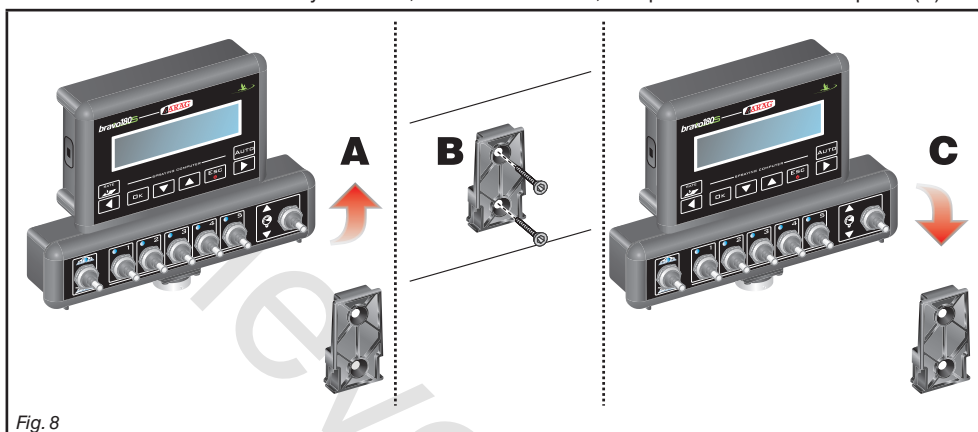

7.4 Control unit position

The control unit must be fixed with the special brackets supplied and fitted to the unit, positioning it as shown in the manual provided with the assembly.



MAKE SURE TO FOLLOW ALL THE SAFETY INSTRUCTIONS GIVEN IN THE CONTROL UNIT'S MANUAL.

7.5 Hydraulic unit positioning

The hydraulic unit shall be secured to the machine, making sure it is well protected against the elements and the fluid sprayed by the machine.



ARAG IS NOT LIABLE FOR ANY DAMAGE RESULTING FROM THE INSTALLATION BY UNSKILLED PERSONNEL. ANY SYSTEM DAMAGE CAUSED BY A WRONG INSTALLATION AND/OR CONNECTION AUTOMATICALLY VOIDS THE WARRANTY.



WARNING! DO NOT CONNECT HYDRAULIC UNITS OTHER THAN THE SPECIFIED ONES (SEE ARAG GENERAL CATALOGUE). ARAG IS NOT LIABLE FOR ANY DAMAGE TO THE PRODUCT, MALFUNCTION ERRORS AND ANY KIND OF RISK IF THE MODULE IS CONNECTED TO NON ORIGINAL UNITS OR UNITS NOT SUPPLIED BY ARAG.



8 COMPUTER CONNECTION TO THE FARMING MACHINE

8.1 General precautions for a correct harness position

• **Securing the cables:**

- secure the harness so that it does not interfere with moving parts;
- route the harnesses so that they cannot be damaged or broken by machine movements or twisting.

• **Routing the cables to protect against water infiltrations:**

- the cable branches must ALWAYS be faced downwards (see figures below).

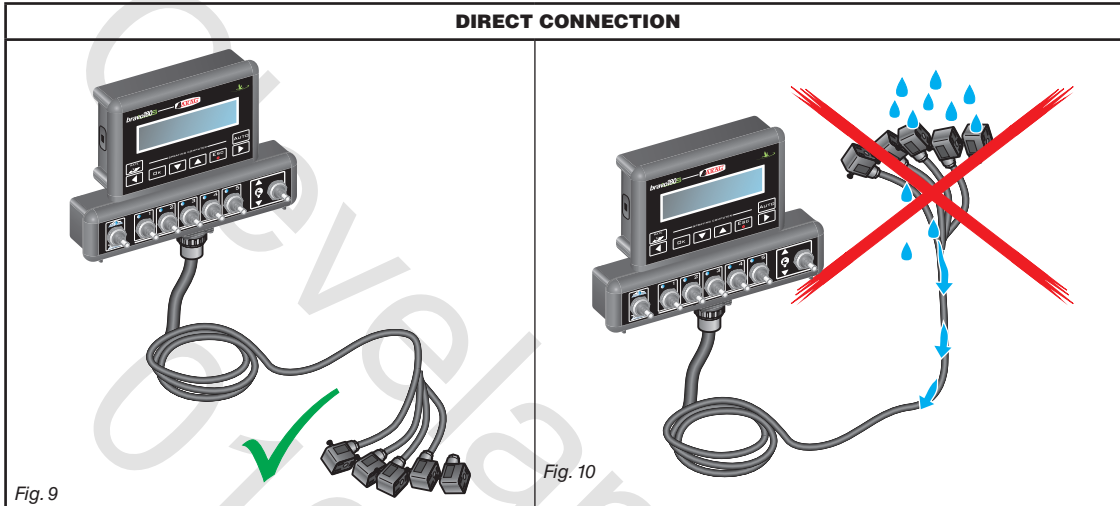

• **Fitting the cables to the connection points:**

- do not force the connectors by pushing too hard or bending them: the contacts may be damaged and computer operation may be compromised.



Use ONLY the cables and accessories indicated in the catalogue, having technical features suitable for the use to be made of them.



8.2 Power supply connection

The package includes the power connector (Fig. 1 and Fig. 2 on page 6) to be connected to the farming machine battery; Fig. 13 shows the drilling template of the power connector. Connect the power connector to the battery wires using two 6-mm faston connectors, as indicated in Fig. 11 and Fig. 12. Use the cable provided with the package (Fig. 1 and Fig. 2 on page 6) to connect the computer to the power supply.

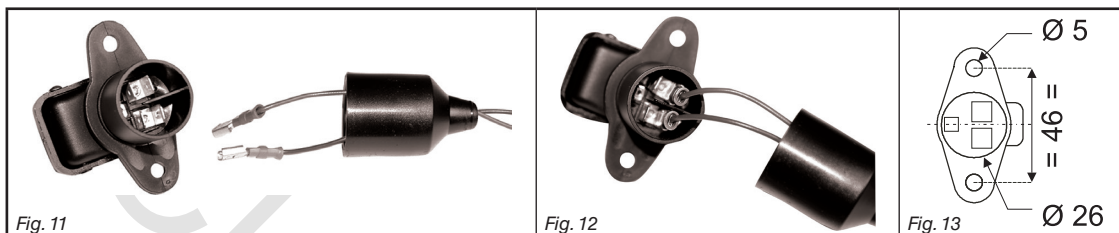

WARNING:

To avoid short circuits, do not connect the power cables to battery before the installation is completed. Before powering up the computer and control unit, make sure the battery voltage is as specified (12 Vdc).

BRAVO 180S is supplied directly by the farming machine battery (12 Vdc): ALWAYS switch on the computer through the monitor, and then remember to switch it off using the specific key on the control panel.



If BRAVO 180S remains on for a long time with the machine off, the tractor battery could run flat: in case of prolonged breaks of the machine with engine off, make sure the computer is off, too.

The power source must be connected as indicated in Fig. 14: the computer must be connected directly to the farming machine battery. DO NOT connect the computer to key-operated switch (15/54).

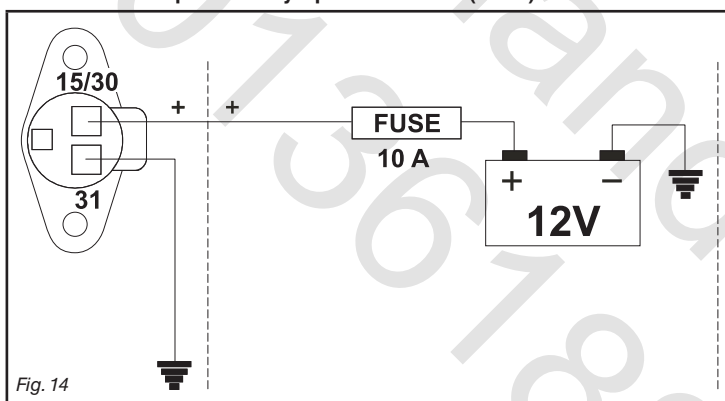

WARNING:

- The power circuit shall ALWAYS be protected by a 10 A fuse like the ones for automotive applications.
 - All cables connected to the battery shall have a minimum cross-section of 2.5 sq. mm.
- To avoid short-circuits, connect the power cable connector only after completing installation.
- Use cables with suitable terminals ensuring correct connection of all wires.



9 HARNESS CONNECTION TO THE CONTROL UNIT, THE HYDRAULIC UNIT AND THE AVAILABLE FUNCTIONS



- Use only the cables provided with the ARAG computers.
- Take care not to break, pull, tear or cut the cables.
- Use of unsuitable cables not provided by ARAG automatically voids the warranty.
- ARAG is not liable for damages to the equipment, persons or animals caused by failure to observe the above instructions.

9.1 Multicore cable connection

Connect the multicore cable to the monitor (connections 1 and 2 on page 9) and the other cable end to the control unit and the hydraulic unit. Ensure it is correctly in place and turn the ring nut clockwise until blocking it.

9.2 Control unit valve connection



- Use ARAG valves: use of unsuitable valves not provided by ARAG automatically voids the warranty. ARAG is not liable for damage to the equipment, persons or animals caused by failure to observe the above instructions.
- All valve connectors must be provided with seals before being connected (Fig. 16).
- Make sure the seals are correctly fitted to avoid water infiltration when using the control unit.

Connector 1 shall control the valve which in turn is connected to the **section 1**, and so on with the other valves. Connect "connector 1" to "valve 1" and then the other connectors with increasing numbers from left to right: **section 1 is the furthest from the machine on the left, looking at the machine from the rear side** (Fig. 15).

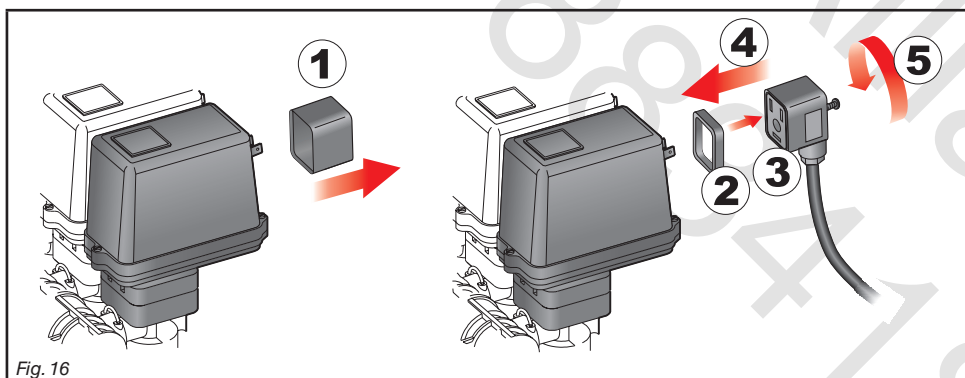
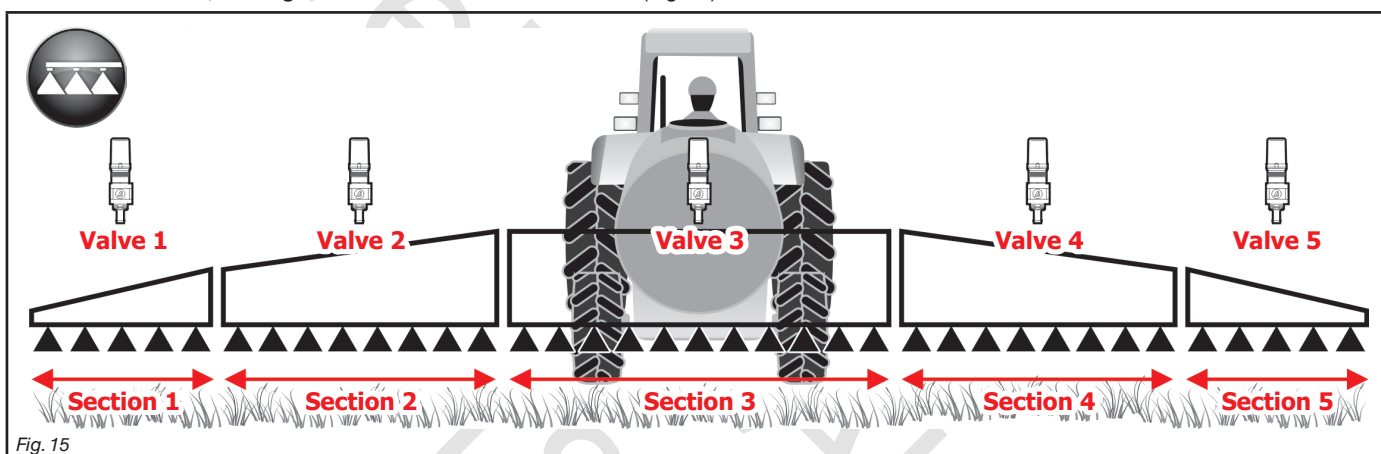

Fix the connectors to the relevant valves according to the initials indicated in your assembly general diagram (7.1 System recommended composition):

- Remove the protection cap (1, Fig. 16) from the electric valve.
- Place the seal (2) onto the connector (3), and push the connector fully on (4): **be careful not to bend the contacts upon insertion on the valve.**
- Tighten the screw (5) fully home.



In case there are more monitor switches than section valves, connect the cables as indicated in the table:

SECTION VALVE NO.	SWITCHES TO BE USED	CABLES TO BE CONNECTED TO THE SECTION VALVES
2	2 - 4	2 - 4
3	2 - 3 - 4	2 - 3 - 4
4	1 - 2 - 4 - 5	1 - 2 - 4 - 5



9.3 Hydraulic valve connection

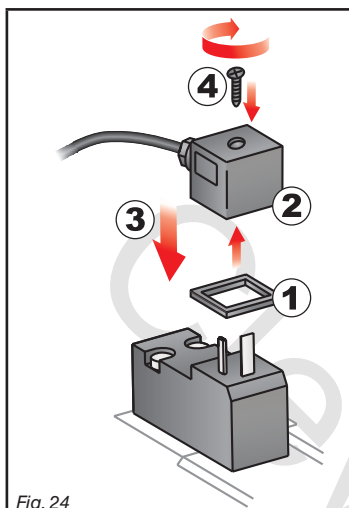

Fig. 24















Bravo 180S can control up to 7 hydraulic functions through double-acting valves.

Fix the connectors to the relevant valves according to the initials indicated in your assembly general diagram (7.1 System recommended composition).

- Position seal (1) onto connector (2), then connect the latter pressing it fully home (3): **during this operation, take special care not to bend valve electric contacts.**
- Insert screw inside connector, and screw it (4) until it is tightened.

The function of each switch on the hydraulic function control panel is described below.

- Connect the connector marked with "DD" to the pilot valve, and then the other connectors, as specified on the table:

CONTROL	MOVEMENT	CONNECTOR
Section movement / AUX switch opening  1 - 4	Opening 	1 ÷ 4 A
	Closing 	1 ÷ 4 C
Boom height  	Opening 	AA
	Closing 	AC
Boom locking  	Opening 	BA
	Closing 	BC
Boom leveling  	Opening 	CA
	Closing 	CC



9.4 Connection of sensors and other available functions

Fix the connectors to the relevant functions according to the initials indicated in your assembly general diagram (par. 7.1).

Harness cables are marked with a symbol denoting their functions: please see the table for correct harness connection.



Use ARAG sensors: use of unsuitable sensors not provided by ARAG automatically voids the warranty. ARAG is not liable for damage to the equipment, persons or animals caused by failure to observe the above instructions.

ITEM	CONNECTION
F	Flowmeter
M	Pressure sensor
R	Foam marker
S	Speed sensor
X	Level sensor
P	Control valve
G	Main valve

- The products are supplied with the sensor installation instructions.

- Connection of:
 - flowmeter;
 - pressure sensor;
 - level sensor
 - foam marker.

All ARAG sensors use the same type of connector. Connect the sensor connector to the relevant harness; make sure it is correctly fitted and push it until locking it.

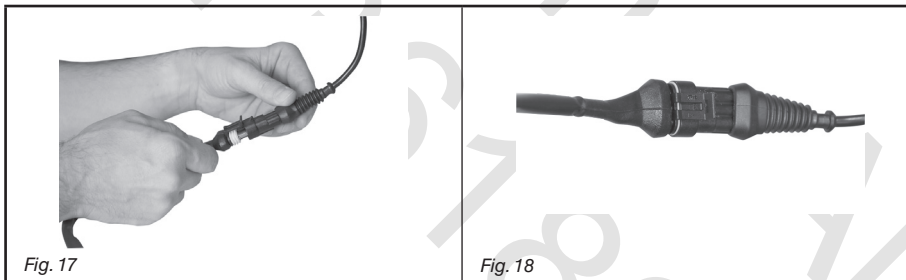

9.5 Pen drive

The pen drive may be used to exchange data with the BRAVO 180S computer.



Before using it make sure the pen drive is not protected. All pen drives with up to 8 GB memory are compatible.



10 SETUP

10.1 Computer switching on/off

• Ordinary switching on

Software version

Fig. 19

Keep key **ESC** pressed until switching on the display: after the software version, Bravo 180S displays the job screen (Fig. 19).

• Switching on to activate the advanced setup

Software version

Job screen

Fig. 20

Contemporaneously press the key sequence until switching on the Bravo. Release key **ESC** keeping pressed the arrow keys until the display shows the Advanced menu (Fig. 20).

• Switching off

Fig. 21

Keep key **ESC** pressed until the display shows the message Power OFF... Release ESC KEY
Release the key and wait for the saving process to complete (Fig. 21); after a few seconds the computer turns off.

During switching off do NOT press any other key and do NOT disconnect the power supply until Bravo 180S turns off.
WARNING: ALWAYS use the special key to switch off the computer; otherwise ALL data concerning the spraying and the programming will be lost.



10.2 Use of keys for setup

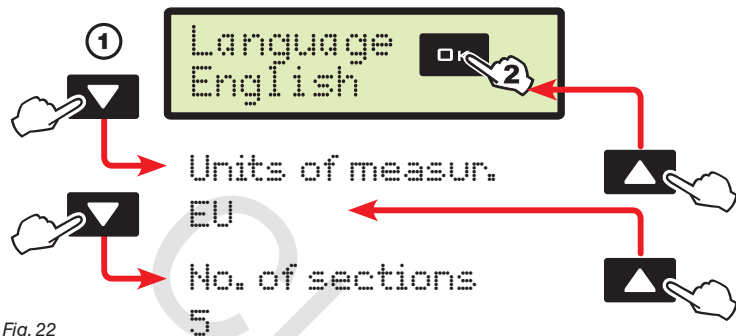

- 1 Press the arrow keys in succession to move across the menu items. (▼ next item, ▲ previous item); the selected item will be displayed (Fig. 22).
- 2 Press **OK** to access the menu: during set-up, a cursor blinks on the display (Fig. 23).

Fig. 22

DATA SELECTION



When it is about a simple selection of data, BRAVO 180S displays the active value (Fig. 23):

- 3a Press the arrow keys in succession to select another value. (▲ next value, ▼ previous value); the selected value will be displayed.
 - 4a Confirm with **OK**.
- Quick scrolling: keep one of the arrow keys pressed.
Exit without confirming the change: press **ESC**.*

Fig. 23

ACCESS TO A SUBMENU



If there is a sub-menu, BRAVO 180S displays three dots " . . ." (Fig. 24):

- 3b Press **OK** to access to the submenu.
 - 4b Press repeatedly to toggle from one item to another of the submenu (▲ next item, ▼ previous item); the selected item will be displayed.
 - 5b Click **OK** to access the selected item.
- Quick scrolling: keep one of the arrow keys pressed.
Press **ESC** to go back to the previous level of the menu.*

Fig. 24

ENTERING A NUMERICAL VALUE

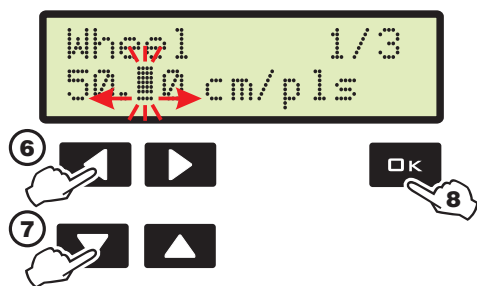

- 6 Press in succession to move the cursor across the digits (◀ shifting to the LEFT, ▶ shifting to the RIGHT).
 - 7 Press in succession to change the value selected by the cursor. (▲ increase, ▼ decrease).
 - 8 Press **OK** to confirm the data.
- Quick increase / decrease: keep one of the arrow keys pressed.
Exit without confirming the change: press **ESC**.*

Fig. 25

Below is a summary of key functions during setup.

		Shifting of the cursor			Menu item scrolling or Data increase/decrease		Confirms access to menu or data change		Quits the menu or the data change		Par.10.2
--	--	------------------------	--	--	---	--	--	--	-----------------------------------	--	----------



11 ADVANCED SETUP

The computer can be set-up with the all data required to ensure a correct distribution of the treatment product. This operation must be done once only, **when installing the computer.**

11.1 Tests and checks before programming

Before computer setup, check:

- that all components are correctly installed (control unit and sensors);
- the correct connection to the power source;
- the component connection (main control unit and sensors).

Failure to correctly connect system components or to use specified components might damage the device or its components.

ACCESS TO ADVANCED MENU



Fig. 26

Advanced setup (with computer off)

- Contemporaneously press the key sequence until switching on the Bravo.
- Release the key **ESC** by keeping the arrow keys pressed until the menu is displayed.



For a correct use of the keys during setting, refer to par. 10.2.

The minimum and maximum values relevant to the data that can be set are indicated in chap. 16.

ADVANCED MENU - STRUCTURE

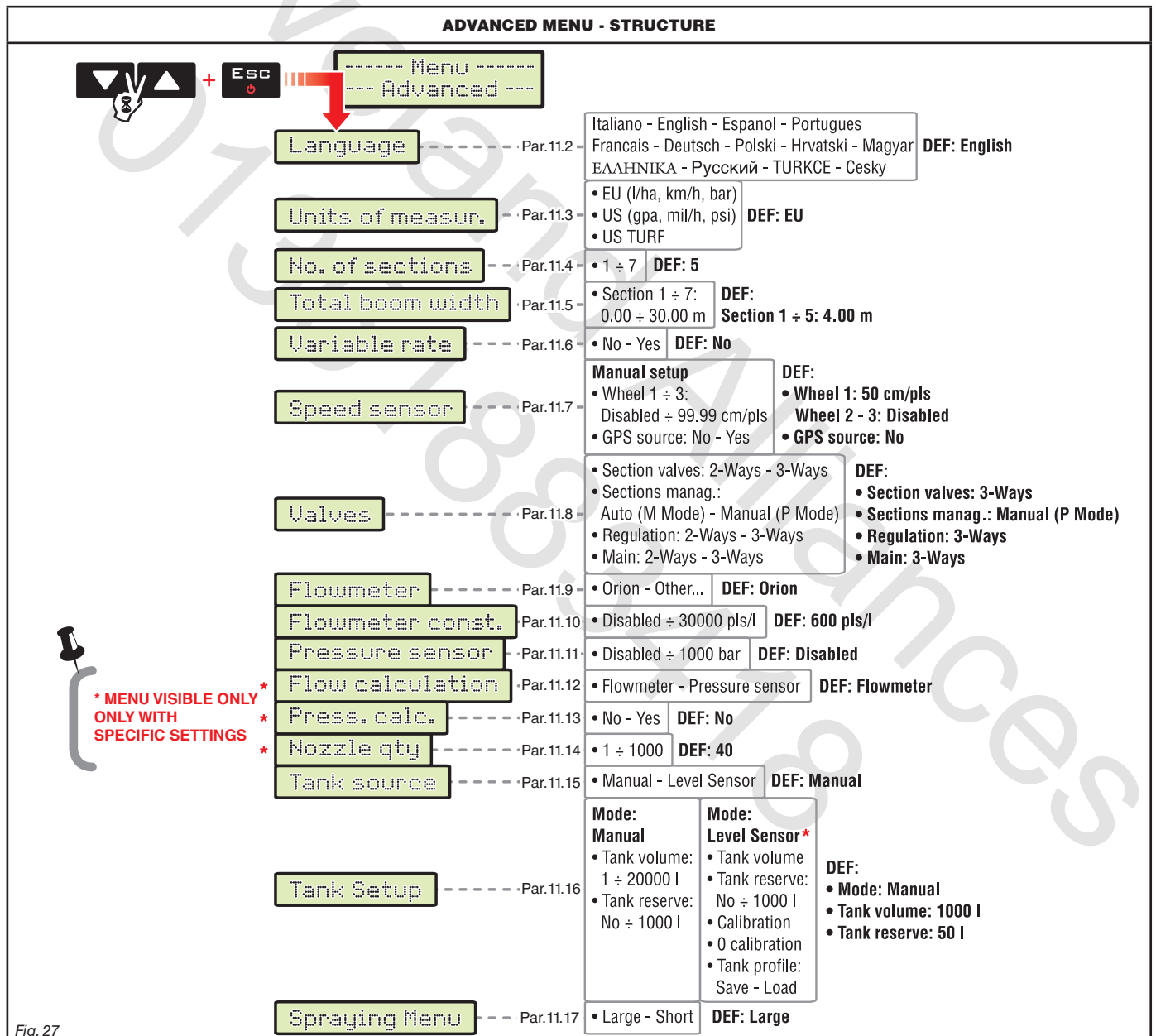

Fig. 27

The screens indicated in the following paragraphs refer to setup key-points only; The display could change when pressing the keys described in the text. When setting the data, the relevant value blinks on the display.

		Shifting of the cursor			Menu item scrolling or Data increase/decrease		Confirms access to menu or data change		Quits the menu or the data change		Par.10.2
--	--	------------------------	--	--	---	--	--	--	-----------------------------------	--	----------



11.2 Language



Fig. 28

Set the language of Bravo 180S, among those available.

- > Italian, English, Spanish, Portuguese, French, German, Polish, Croatian, Hungarian, Greek, Russian, Turkish, Czech.

11.3 Units of measur.



Fig. 29

Set the units of measurement used for Bravo 180S.

- > EU (l/h, km/h, bar)
- US (GPA, mil/h, PSI)
- US TURF (applied volume = gal / 1000 square feet, mil/h, PSI)

11.4 No. of sections



Fig. 30

Set the number of installed section valves.

11.5 Total boom width

This parameter represents the nozzle actual spraying range on the ground: for example, by positioning 8 nozzles at a distance of 50 cm one from the other, the boom section width to be set is 4.00 m. The displayed value (Fig. 31) represents the sum of the section width values, therefore to change the parameter it is necessary to set the width of each boom section: the sum of the width values will be re-calculated automatically.

- 1 After selecting the menu Total boom width, press **OK** to gain access to the sub-menu to select / modify the single sections.
- 2 Use the keys to scroll the sections in the sub-menu Section until viewing the section to be modified: the section number is indicated on the top right side of the display, whereas the first line shows the current value (Fig. 32).
- 3 Press **OK** to confirm the access to the modification function.
- 4 Enter the section width value and repeat the setting procedure for each section.



Fig. 31

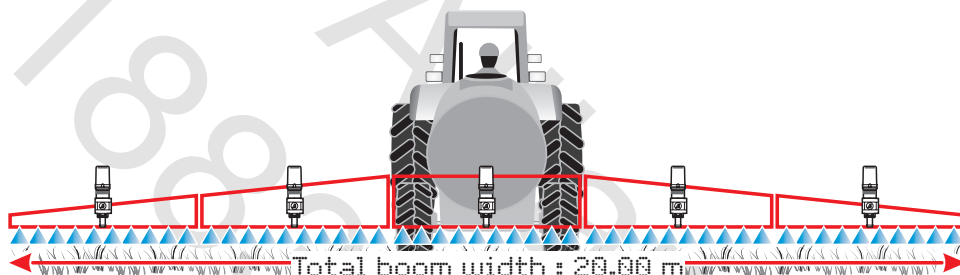

Fig. 32

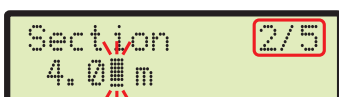
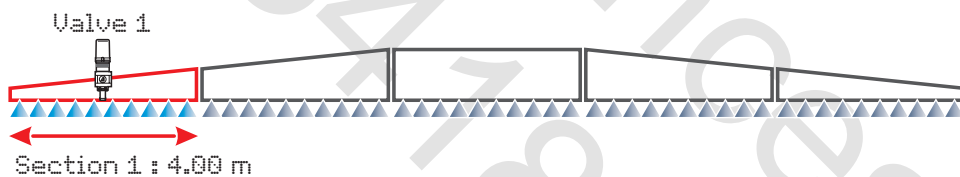
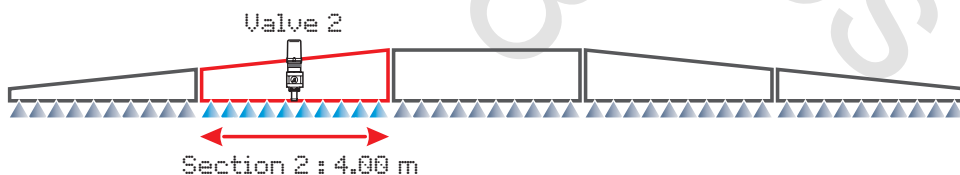

Fig. 33



11.6 Variable rate

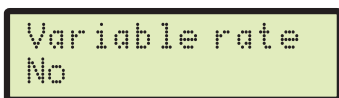

Fig. 34

Enable / disable the variable application rate.

- > No
- Yes

With option Yes, the computer is preset to select the application rate Variable when setting the jobs (par. 12.1).



Shifting of the cursor



Menu item scrolling or Data increase/decrease

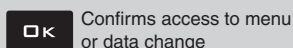

Confirms access to menu or data change

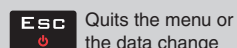

Quits the menu or the data change





11.7 Speed sensor

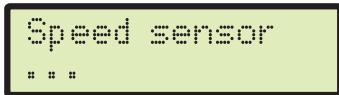

Fig. 35

In this menu carry out all settings to calculate the speed. Usually the computer calculates the information concerning the speed thanks to pulses received by the sensor installed on the wheel. If a GPS receiver is directly connected to the Bravo 180S, this menu allows selecting the receiver as alternative source to the wheel sensor, and so to receive in real time the speed data provided by the GPS.

After selecting the menu Speed sensor, press **OK** to access the sub-menus.

> Wheel

This parameter is used by the BRAVO 180S computer to calculate the vehicle driving speed and, according to this, the instantaneous application rate. The wheel constant relates to the type of wheel being used and the number of detection points of the sensor installed on it. BRAVO 180S can save 3 different wheel constants.

In case of replacement of the wheel featuring the detection points of the speed sensors, the wheel constant can change. In this case it is necessary to set the parameter again.

- 1 Select the wheel type (3 types available).
- 2 Press **OK**. The constant can be entered with two different procedures (Manual setup or Automatic calc.), described below.
- 3 Select the desired procedure and press **OK** to enter the constant.



Fig. 36



Fig. 37

4a Manual setup

Allows to enter the wheel constant value calculated with the suitable formula.



Fig. 38

Take measurements with tyres at the operating pressure.

$$K_{wheel} = \frac{\text{distance traveled (cm)}}{\text{no. of detection points} \times \text{wheel rpm}}$$

<distance traveled> distance expressed in cm covered by the wheel along measurement travel.

<no. of measurement points> number of measurement points

(e.g. magnets, bolts, etc.), mounted on wheel.

<no. of wheel revolutions> number of wheel revolutions required to travel measurement distance.

The wheel constant can be calculated with a good approximation by detecting the distance traveled by the wheel with the speed sensor.

(The longer the distance traveled, the more accurate wheel constant calculation).

4b Automatic calc.

BRAVO 180S can automatically calculate the wheel constant using the number of pulses sent by the speed sensor when driving on a 100 m (EU) / 300 feet (US - US TURF) straight path.



Fig. 39



- After selecting Automatic calc. (point 3), the display indicates that it is possible to move forward with the vehicle.
- Cover the requested distance: the number of pulses will increase during the path. Stop the tractor at the end of the distance.
- Press **OK** to stop the counting. The computer will indicate the calculated constant. Wheel constant has been saved.

Take measurements with tyres at the operating pressure. This test must be performed on medium-hard terrain; for application to very soft or very hard terrain, rolling diameter may vary, leading to inaccurate output calculation; when this is the case, repeat the procedure.

During the test cover the distance with the tank filled up to half capacity with water.

Error!

Alarm displayed during the automatic calculation: repeat the procedure, calculation not valid; the error can occur even if the wheel has been replaced in a wrong way or if the sensor is too far from the detection points.

In this case check the sensor installation and repeat the procedure.

If the problem persists, contact the installer.



Fig. 40

> GPS source

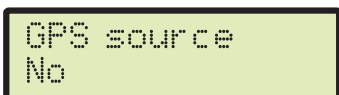
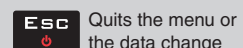
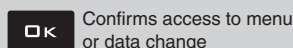
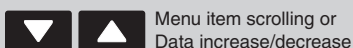

Fig. 41

- > No
- Yes

With option Yes, the computer is preset to receive speed data from the GPS receiver directly connected to the auxiliary port.





11.8 Valves



Set the type of valves installed on the system and the relevant data. After selecting the menu Valves, press **OK** to gain access to the sub-menus.



Fig. 42

- > Section valves: indicate the type of installed section valves.
 - 2-Ways: valves without calibrated backflows
 - 3-Ways: valves with calibrated backflows

- > Sections manag.
Indicate the section valve operation mode, especially if the section automatic closing is active when the main control valve is closed.

- Manual (P Mode)
- Auto (M Mode)

- "P" operation mode (option Manual):
The section valves are controlled independently. Main switch control functions do not affect section valve opening or closing.
- "M" operation mode (option Auto):
The section valves are closed or opened acting on the main switch provided the section valve specific switch is in the correct position, i.e. if the section switches are set to OFF (lever down), acting on the main switch the sections will not be controlled. If one or more section valve switches are set to ON (lever up), opening or closing the main switch opens or closes the section valves as well.

- > Regulation: indicate the type of installed control valve.



- > Main: indicate the type of installed main control valve.
 - 2-Ways: drain valve (valve TYPE - Arag 463 series)
 - 3-Ways: main valve (valve TYPE - Arag 464 - 471 series)

11.9 Flowmeter

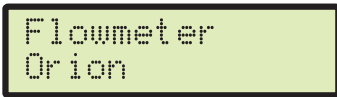

Select the type of flowmeter installed:
Orion
Other...

Fig. 43

11.10 Flowmeter constant

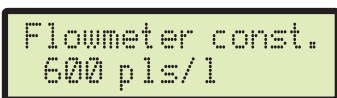

This parameter sets the flowmeter constant value: it indicates how many pulses are sent by the flowmeter per unit of sprayed fluid.

The constant value is indicated on the label on your flowmeter. For the parameter value of ORION flowmeters only, to be entered in the computer, refer to section "Technical data" of the User manual attached to the flowmeter.

Fig. 44



11.11 Pressure sensor



Fig. 45

Indicate the full scale of the pressure sensor installed on the system. If there is no pressure sensor, set item Disabled.

11.12 Flow calculation *

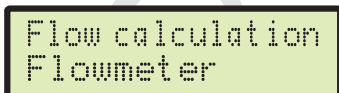

Fig. 46

Set the type of sensor to be used to calculate the rate:

- > Flowmeter
- Pressure sensor

*** MENU VISIBLE ONLY WITH SPECIFIC SETTINGS: TO VIEW IT, ENABLE BOTH THE INDICATED OPTIONS.**

- Flowmeter const. ✓ par. 11.10
- Pressure sensor ✓ par. 11.11

11.13 Pressure calculation *

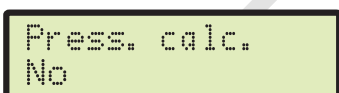

Fig. 47

This parameter allows deciding whether you want to display a pressure value in the Spraying menu calculated according to the rate detected by the flowmeter and the selected nozzle.

- > No
- Yes

*** MENU VISIBLE ONLY WITH SPECIFIC SETTINGS: TO DISPLAY IT YOU MUST DISABLE THE SHOWN OPTION.**

- Pressure sensor ✗ par. 11.11

11.14 Nozzle quantity *



Fig. 48

This parameter allows setting the total number of nozzles installed on the boom.

With this parameter BRAVO 180S calculates the system pressure according to the rate detected by the flowmeter, or the system rate based on the pressure detected by the relevant sensor (according to the device being used, par. 11.12).

*** MENU VISIBLE ONLY WITH SPECIFIC SETTINGS: TO VIEW IT, ENABLE ONE OF THE INDICATED OPTIONS**

- Flow calculation > Pressure sensor par. 11.12
- Press. calc. ✓ par. 11.13

11.15 Tank source

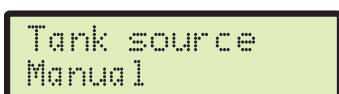

Fig. 49

In this menu select a tank level reading mode.

The management of the Tank source, described in par. 11.16, will be different according to the selected mode.

Possible options:

- > Manual
- Level Sensor

The level sensor installed in the system allows displaying the tank level in real time.

This mode operates correctly ONLY if the level sensor has been calibrated, or if the calibration of a similar tank has been loaded from pendrive.

The procedure is described below, under section Tank profile > Load.

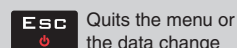
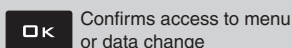
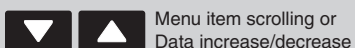



11.16 Tank Setup



Allows to set data relevant to the tank.
After selecting the menu Tank Setup, press **OK** to gain access to the sub-menus.



Fig. 50

> Tank volume (can be modified only in mode Tank source > Manual)

This parameter sets the quantity of fluid the tank can contain: it indicates the maximum quantity of fluid that can be filled in the tank by the user. If there is a level sensor, the computer displays the tank capacity calculated after the calibration.

> Tank reserve

This parameter sets the "reserve" value below which the computer triggers a visual and acoustic alarm: when the reserve value is reached during the spraying, the tank symbol (Fig. 51) blinks on the display.

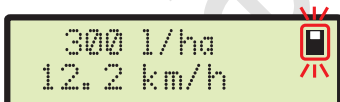

The acoustic alarm stops when the tank is completely empty.

Fig. 51

> Calibration * : enters the calibration procedure of the level sensor.



*** MENU VISIBLE ONLY WITH SPECIFIC SETTINGS:
TO VIEW IT, ENABLE THE INDICATED OPTION.**

Tank source > Level Sensor 11.15

! The level sensor calibration is **ONLY** possible if the system is provided with a flowmeter (par. 11.9 and 11.10).
Before starting the procedure carry out the following operations:

- 1 Make sure that the main switch is in the OFF position.
- 2 Fill in the tank with clean water **WITHOUT ADDING CHEMICAL SUBSTANCES**.
The tank must be full. Visually check the reached level.

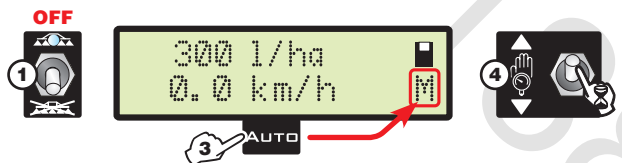

- 3 From the job screen check that the manual mode is active (the display shows M).
Otherwise activate it by pressing **AUTO**.

- 4 Set the output to the maximum value by keeping the control valve switch pressed (nearly 7 s).

- 5 Switch off the computer and on again in advanced setup mode.

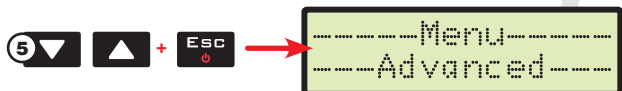

- 6 Enter the Tank source menu, activate the Level Sensor mode.

- 7 Enter the Tank Setup menu and select Calibration.

- 8 Bravo 180S requests to enter the tank capacity: enter the value.



- 9 Immediately after that, the computer passes to the calibration start screen: the display shows the message Calib. phase > Activate Main.

- 10 Start the spraying system: open, in succession, ALL section valves and the main control (switches in position ON).
The display shows the message Calib. phase > In progress...
Press **ESC** to interrupt the calibration without saving.

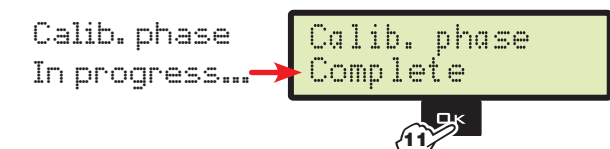

- 11 When the rate value reaches zero and remains so for at least 10 s, Bravo 180S automatically finishes the procedure and displays the message Calib. phase > Complete.
Press **OK**: the calibration is finished and saved and replaces the current calibration.

After having completed the calibration and checked the sensor correct operation, we recommend to memorise the calibration on pendrive (menu Tank profile > Save on page 24).



> 0 calibration *



Fig. 52

It activates the "zero" calibration procedure of level sensor. If a fluid is detected in the tank even if it is empty, it is necessary to calibrate the level sensor zero. - Press **OK** to reset the sensor residual signal.

! Check sensor!

Faulty values detected: check the sensor operation. If problem persists, check for residual fluid in the tank.

> Tank profile *



Fig. 53

The level sensor calibration can be loaded or saved on pendrive to reconfigure the device if necessary, solve problems, or configure another Bravo 180S without having to repeat all operations. Before any other operation, insert the pendrive in its slot (par. 7.2).

> Save: select this option and press **OK**.

The confirmation message Ok TANK.TKL is displayed once the saving process is completed.

! USB not found

Saving alarm: pendrive not inserted.

> Load: select this option and press **OK**.

The confirmation message Ok TANK.TKL is displayed once the configuration process is completed.

! USB not found

File not found

Configuration alarms:

- Pendrive not inserted.
- The tank configuration TANK.TKL is not saved on the pendrive.



*** MENU VISIBLE ONLY WITH SPECIFIC SETTINGS: TO VIEW IT, ENABLE THE INDICATED OPTION.**

Tank source > Level Sensor par. 11.15

11.17 Spraying Menu

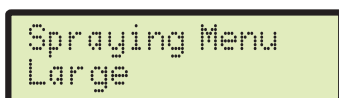

Fig. 54

Upon spraying it is possible to display and check in real time the current spraying data. BRAVO 180S can display such data in extended or short mode.

The table indicates the two display modes:

Data	extended	short
Speed	•	•
Pressure**	•	•
Flowrate	•	•
Surface	•	•
Sprayed fl.	•	•
Tank level	•	--
Time	•	--
Distance	•	--



**** MENU VISIBLE ONLY WITH SPECIFIC SETTINGS: TO VIEW IT, ENABLE ONE OF THE INDICATED OPTIONS**

Pressure sensor ✓ par. 11.11

Press. calc. ✓ par. 11.13



12 USER SETTING

Before starting a treatment, some settings are necessary for a correct job.
Once all necessary data have been set, it is possible to immediately start spraying.

ACCESS TO THE USER MENU



Fig. 55

User setting (from computer on)

- Keep key **OK** pressed until the menu is displayed.

For a correct use of the keys during setting, refer to par. 10.2.

The minimum and maximum values relevant to the data that can be set are indicated in chap. 16.

USER MENU - STRUCTURE

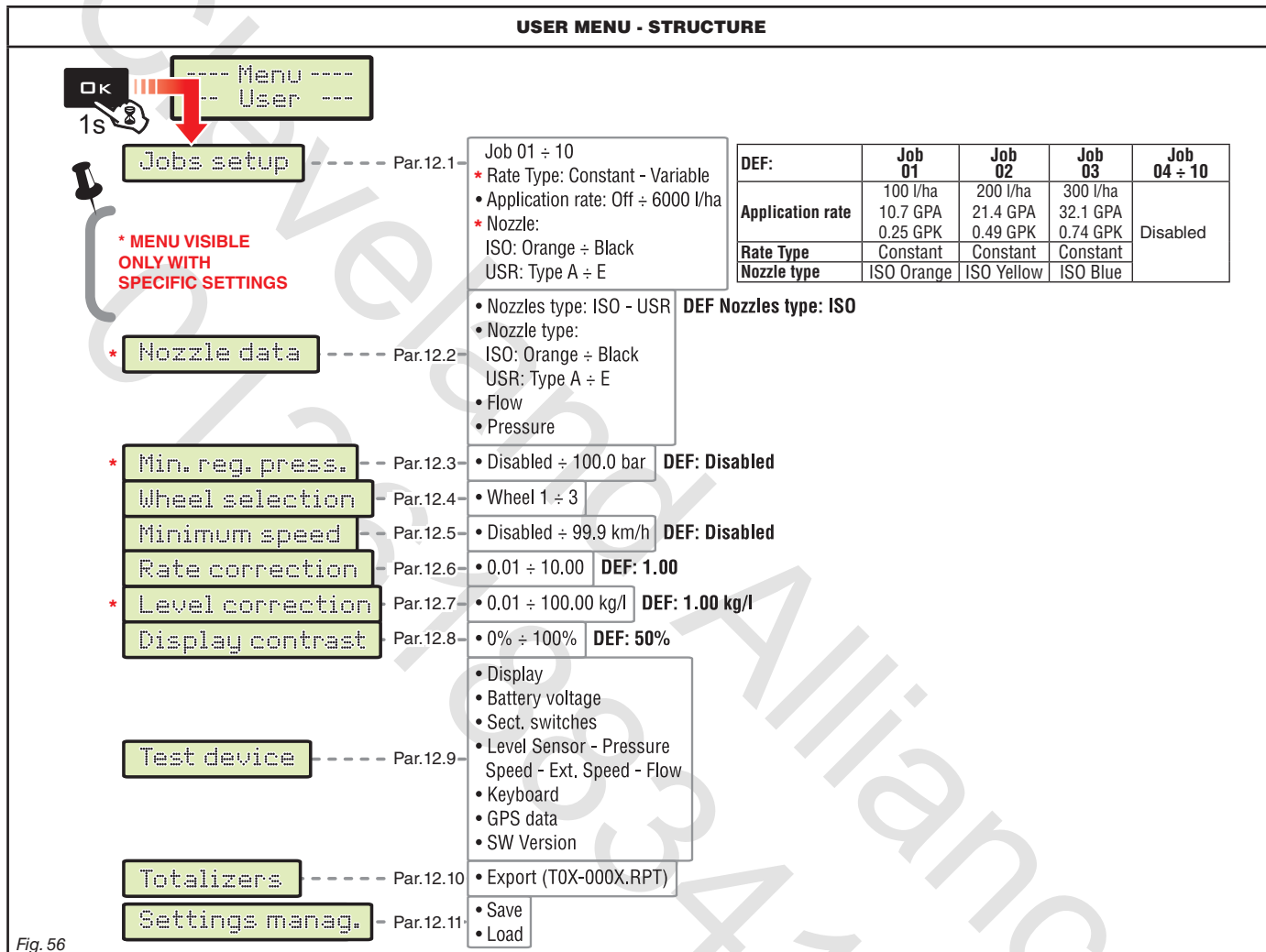

Fig. 56



The screens indicated in the following paragraphs refer to setup key-points only.

The display could change when pressing the keys described in the text.

When setting the data, the relevant value blinks on the display.



Shifting of the cursor



Menu item scrolling or Data increase/decrease



Confirms access to menu or data change



Quits the menu or the data change



Par.10.2



12.1 Jobs setup

In this menu it is possible to set 10 different types of treatments.



Job number



Fig. 57

- First select the job to be set (Fig. 57).



Fig. 58

- After selecting the job, the computer automatically passes to the setting screen of Rate Type* for the selected treatment (Fig. 58):

Constant: Bravo 180S carries out the treatment by keeping the set application rate.

Variable: with the Variable option, BRAVO 180S changes the output according to the data sent by the Skipper satellite navigator (duly connected), that indicate the exact quantity of fluid to be sprayed in each point of the field.

- Press **OK** to automatically pass to the setting screen of the other parameters (Fig. 59).

* MENU VISIBLE ONLY WITH SPECIFIC SETTINGS:
TO VIEW IT, ENABLE THE INDICATED OPTION.

Variable rate ✓ par. 11.6



Job number

Fig. 59



- A** Set application rate: set the application rate for the selected treatment.
- B**** Type of nozzle: set the type of nozzle (ISO or USR).
- C**** Nozzle: select the nozzle among those available in the ISO or USR type.

The **RATE** key allows passing from one setting to the other; the value that can be modified blinks.

Press **OK**, in this screen, to confirm the setting of the entire job and automatically go back to the job selection (Fig. 57).

- Repeat the setup FOR EACH job (set the used types and disable the others).

** MENU VISIBLE ONLY WITH SPECIFIC SETTINGS:
TO VIEW IT, ENABLE ONE OF THE INDICATED OPTIONS.

Flow calculation > Pressure sensor par. 11.12

Press. calc. ✓ par. 11.13

3603418 Alliances



12.2 Nozzle data *

This menu allows setting and viewing the values of the nozzles being used.



Fig. 60



- First select Nozzles type (ISO or USR, Fig. 60).
- Then the computer automatically passes to the selection of the nozzle to be set (Fig. 61).



ISO nozzles CAN NOT BE MODIFIED.



Fig. 61



- Press **OK** to automatically pass to the setting of the flowrate for the selected nozzle (Fig. 62).
- Press **OK** to automatically pass to the setting screen of the reference pressure (Fig. 63).



Fig. 62

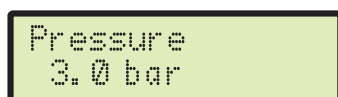

Fig. 63



- Repeat the setup for each available "user" nozzle.
- The data of the nozzle being used allow Bravo 180S to calculate the pressure without a pressure sensor.

NOZZLES

Nozzle type ISO	Unit of measurement EU		Unit of measurement US - US TURF	
	Flowrate (l/min)	Pressure (bar)	Flowrate (GPM)	Pressure (PSI)
ISO Orange	0.40	3.00	0.100	40
ISO Green	0.60	3.00	0.150	40
ISO Yellow	0.80	3.00	0.200	40
ISO Lilac	1.00	3.00	0.250	40
ISO Blue	1.20	3.00	0.300	40
ISO Red	1.60	3.00	0.400	40
ISO Brown	2.00	3.00	0.500	40
ISO Gray	2.40	3.00	0.600	40
ISO White	3.20	3.00	0.800	40
ISO Light blue	4.00	3.00	1.000	40
ISO Light green	6.00	3.00	1.500	40
ISO Black	8.00	3.00	2.000	40

Nozzle type USR (USER)	Unit of measurement EU		Unit of measurement US - US TURF	
	Flowrate (l/min)	Pressure (bar)	Flowrate (GPM)	Pressure (PSI)
Type A	1.00	3.00	0.264	40
Type B	2.00	3.00	0.528	40
Type C	3.00	3.00	0.793	40
Type D	4.00	3.00	1.057	40
Type E	5.00	3.00	1.321	40



* MENU VISIBLE ONLY WITH SPECIFIC SETTINGS:
TO VIEW IT, ENABLE ONE OF THE INDICATED OPTIONS.

Flow calculation > Pressure sensor par. 11.12

Press. calc. ✓ par. 11.13



Shifting of the cursor



Menu item scrolling or Data increase/decrease



Confirms access to menu or data change



Quits the menu or the data change





12.3 Minimum regulation pressure *

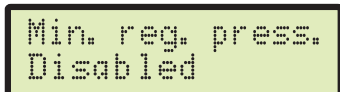

Fig. 64

This menu allows setting a pressure value below which BRAVO 180S blocks the automatic regulation function (Disabled: block disabled).



The control is active **ONLY** during treatment **AUTOMATIC** control (par. 14.3.1). For the procedure to be followed in case of alarms, please refer to par. 15.1 Operation errors.

*** MENU VISIBLE ONLY WITH SPECIFIC SETTINGS:
TO VIEW IT, ENABLE ONE OF THE INDICATED OPTIONS.**

- Pressure sensor ✓ par. 11.11
- Press. calc. ✓ par. 11.13

12.4 Wheel selection **



Fig. 65

Once the wheel constants (max. 3) have been saved, they can be retrieved as selection of the wheel type. As an alternative it is possible to retrieve the GPS source, only if it is enabled in the advanced setting.

The display will show only the types of wheel for which a constant has been set.

Type of wheel



**** MENU VISIBLE ONLY WITH SPECIFIC SETTINGS:
TO VIEW IT, ENABLE ONE OF THE INDICATED OPTIONS**

- At least 2 types of Wheel ✓ par. 11.7
- 1 type of Wheel + GPS source ✓ par. 11.7

12.5 Minimum speed

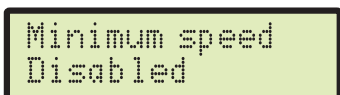

Fig. 66

BRAVO 180S interrupts the spraying when the detected speed is lower than the set one. (Disabled: block disabled).



The control is active **ONLY** during treatment **AUTOMATIC** control (par. 14.3.1). For the procedure to be followed in case of alarms, please refer to par. 15.1 Operation errors.

12.6 Rate correction

When using a paddle flowmeter and the sprayed fluid has a different density than the water one, the computer could display wrong measurements; to correct them change the sprayed fluid factor:

- if at the end of the spraying the tank still contains fluid, reduce the factor;
- if the fluid finishes before the job has ended, increase the factor.



Fig. 67

Set the density factor of the sprayed fluid.



Flowmeters of the **ORION** series (code 462xxx) are not affected by the density difference of the fluids: set the factor to 1.00.



Shifting of the cursor



Menu item scrolling or Data increase/decrease



Confirms access to menu or data change



Quits the menu or the data change



Par.10.2



12.7 Level correction *



Fig. 68

If the sprayed fluid has a different density than the water one, the computer could display wrong measurements; to correct them change the sprayed fluid weight for 1 l of product.

* MENU VISIBLE ONLY WITH SPECIFIC SETTINGS: TO VIEW IT, ENABLE THE INDICATED OPTION.

Tank source > Level Sensor par. 11.15

12.8 Display contrast



Fig. 69

Allows adjusting the display contrast.

12.9 Test device



Allows checking the correct operation of Bravo 180S.

Tests are **READING-ONLY** data.

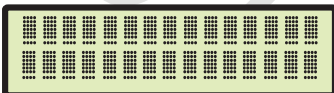

Fig. 70

Display operation test.

> Battery voltage

Bravo 180S displays the supply voltage.

> Sect. switches

Working on the control panel switches it is possible to test their operation.

- M Main control ON
- 1+7 Section valves ON (the display shows the number of present sections)
- + / - Proportional regulation (+ increase / - decrease)
- E Presence of an external main control to start the spraying

> Level Sensor

- Pressure
- Speed
- Ext. Speed
- Flow

The computer detects frequency and current sent by each sensor on the system.

> Keyboard

Press the keys to view the relevant item.

Keys:

- RATE KEY
- LEFT KEY
- OK KEY
- RIGHT KEY
- AUTO KEY

> GPS data

- Latitude
- Longitude
- Satellites
- HDOP
- Status
- Update frequency

If you connect a satellite receiver or a SKIPPER navigator, Bravo 180S displays the received GPS data.

> SW Version

Bravo 180S displays software versions.



Shifting of the cursor



Menu item scrolling or Data increase/decrease



Confirms access to menu or data change



Quits the menu or the data change





12.10 Totalizers

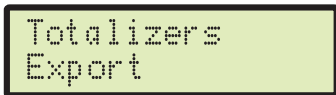

Fig. 71

- there is a totalizer for each preset job (10 available), plus the "T00" one (that can not be reset) which includes all jobs performed by the device.
- the current job data are summed to the relevant totalizer each time you select a new job (par. 14.1).
- It is possible to save the totalizer reports on pendrive using the relevant function Export (Fig. 71).
- it is possible to delete all job data (par. 14.2).

TOTALIZER RECORD FILE

File name structure:

T01-0003.RPT

Reference job number Progressive number

(01÷10)

Fig. 72

• SAVING THE TOTALIZER ON PENDRIVE

- Select Export (Fig. 71) and press **OK**.
- In the example of Fig. 72, Bravo 180S saves the **T01-0003.RPT** file on the pendrive.
- At each following saving the computer will increase the report number (**T01-0004.RPT**, etc.)

Data in the file can be displayed on Personal Computer with a text editor. Each file will contain the following data*:

Job's data

```
Job No.       : 01 [Active]
Area         : 0.000 ha
Sprayed qty  : 0 l
Time        : 00:00 h
Productivity : 0.0 ha/h
Target rate  : 300 l/ha
Rate applied : 0 l/ha
Nozzle type  : ISO-Blue
Nozzle qty   : 40
Distance    : 0.000 km
```

* These data represent just a mere example. In real facts they will always be different according to the type of treatment .

12.11 Settings manag.

The Bravo 180S settings can be loaded or saved on pendrive so as to reconfigure the device if necessary, solve problems or configure another Bravo 180S without repeating all operations manually.

Once installation is completed, and you checked machine correct operation, we recommend you to store the whole configuration onto pendrive.

To use the menu items insert the pendrive in the suitable slot (par. 7.2).

> Save



Fig. 73

Allows saving the Bravo 180S configuration on the pendrive: then it will be possible to load it any time it is necessary to repeat the same settings.

- Select Save (Fig. 73) and press **OK**;
- The confirmation message **Ok: SETUP.BIN** is displayed once the saving process is completed.
- Press **ESC**.

Saving alarms:

USB not found *Pendrive not inserted.*
Error!

Space available on pendrive is over: eliminate some files from the memory and try saving again.
If the problems persist, please contact the service centre.
File not found
The SETUP.BIN configuration has not been saved on the pendrive.

> Load

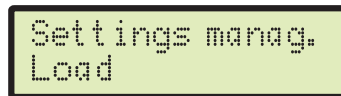

Fig. 74

Allows to select a configuration file saved on the pendrive and to set Bravo 180S again.

WARNING: BY LOADING IN THE BRAVO 180S THE SETUP.BIN FILE SAVED ON THE PENDRIVE, ALL SETTINGS CARRIED OUT SO FAR WILL BE LOST.

- Select Load (Fig. 74) and press **OK**;
- The confirmation message **Ok: SETUP.BIN** is displayed once the configuration process is completed.
- Press **ESC**.

USB not found

Configuration alarm: pendrive not inserted.



13 USE

13.1 Display

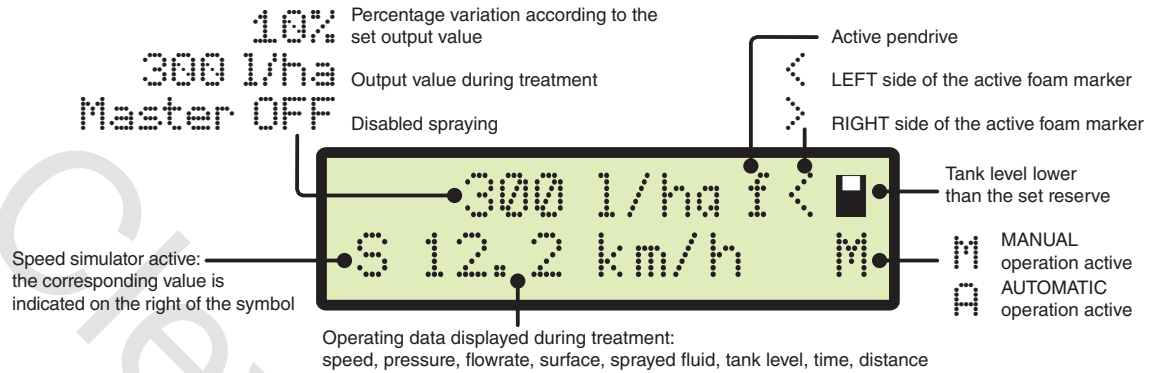

Fig. 75

13.2 Controls on computer



Fig. 76

Legend:

- 1 Keys to check the computer and the spraying phases
- 2 Operating switches for control unit valves
- 3 Switches to use the hydraulic functions

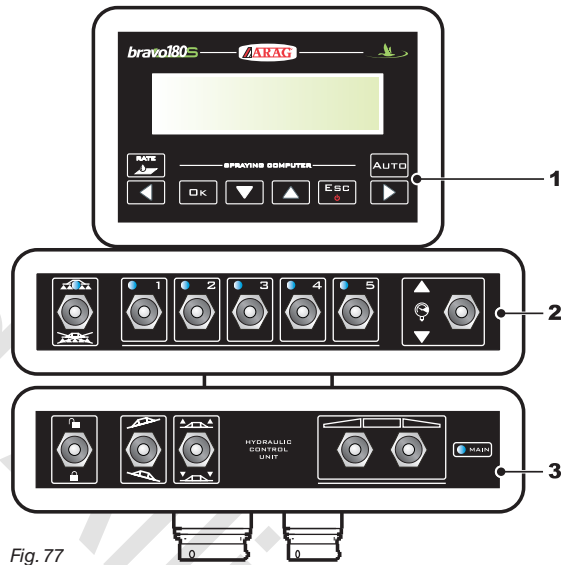

Fig. 77

13.2.1 Keys to check the computer and the spraying phases

Change value of output *	LEFT Foam marker	Data confirmation	Data decrease / browsing	Data increase / browsing	ON/OFF Quit data modification	RIGHT Foam marker	Manual / Automatic Output

* It allows resetting or setting the increase/decrease percentage of the output value.

13.2.2 Operating switches for control unit valves

Upon computer switching on, if main control is set to ON, the message **Disable Main** will be displayed: no function can be accessed until main control is set again to OFF.

Main control ON	Main control OFF	Open section	Closed section	Increase of output*	Decrease of output*

* Manual function: increases/decreases the quantity of fluid to be sprayed; Automatic function: increases/decreases the quantity of fluid to be sprayed at intervals of 10% with respect to the set value.

13.2.3 Operating switches for hydraulic valves

Release of the boom	Block of the boom	Leveling of the boom clockwise	Leveling of the boom counter-clockwise	Increase of the boom height	Decrease of the boom height	Boom section movement: opening	Boom section movement: closing

The LED turns on when one of the possible sprayer movements is activated. Keep the relevant switch pressed to activate the movement. Release it to stop the movement.

**14 TREATMENT PRELIMINARY SETTINGS**

	SET	
TO BE CARRIED OUT UPON FIRST USE OF THE COMPUTER	Speed sensor	11.7
	Boom width	11.5
	Job setup	12.1
	Nozzle data	12.2
	Minimum regulation pressure	12.3
	Minimum speed	12.5
	Display contrast	12.8
	Save settings to pendrive	12.10
TO BE CARRIED OUT BEFORE EACH TREATMENT	Select the wheel type	12.4
	Flowrate correction factor	12.6
	Level correction factor	12.7
	Select the job program	14.1
	Reset the totalizers	14.2
Tank filling	14.5.1	

 After having carried out the indicated settings start the treatment selecting between **MANUAL** (par. 14.3.2) and **AUTOMATIC** (par. 14.3.1) modes.

14.1 Selecting the job program (for automatic control only)

Before starting the treatment select the correct job, among those pre-set in the User Menu (Par. 12.1).



Job number



Fig. 78

- 1 In the Spraying Menu, keep the key pressed to gain access to the job selection section.
- 2 Press to scroll the pre-set jobs.
- 3 Confirm selection.

*** MENU VISIBLE ONLY WITH SPECIFIC SETTINGS:
TO VIEW IT, ENABLE ONE OF THE INDICATED OPTIONS**

Flow calculation > Pressure sensor par. 11.12
Press. calc. ✓ par. 11.13

14.2 Counters reset

Fig. 79



Fig. 80

- 1 In the Spraying Menu, keep the key pressed to gain access to the job selection section.
- 2 Press to scroll the pre-set jobs.
- 3 Press the keys at the same time until viewing the message Reset?
- 4 Press **OK** to confirm the reset.



14.3 Application rate regulation

Bravo 180S regulates the chemical products output in two different ways.

Press the **AUTO** key to select the desired mode: the type of active regulation during the job will be displayed.

14.3.1 Automatic operation (DEFAULT)



Fig. 81

Bravo 180S keeps the set application rate constant regardless of the changes in speed and boom section status.

If necessary, during spraying, it is possible to intervene on the dedicated switch to adjust output to crop conditions, increasing or decreasing momentarily the application rate up to $\pm 50\%$. Press **RATE** to restore the set output value.

- 1 Enable the automatic operation.
- 2 Open the desired section valves.
- 3 Position the tractor at the beginning of the field to be sprayed.
- 4 Turn the main switch to ON.
- 5 Start the treatment.
- 6 Use the control valve switch to temporary change the application rate.



Par.13.2.1 Keys to check the computer and the spraying phases

Par.13.2.2 Operating switches for control unit valves

Par.13.2.3 Operating switches for hydraulic valves

Par.13.1 Display

14.3.2 Manual operation

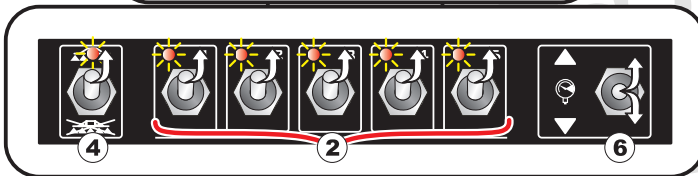

Fig. 82

Rate manual regulation shall be carried out with the suitable switch.

- 1 Enable the manual operation.
- 2 Open the desired section valves.
- 3 Position the tractor at the beginning of the field to be sprayed.
- 4 Turn the main switch to ON.
- 5 Start the treatment.
- 6 Use the control valve switch to adjust the desired quantity.



Par.13.2.1 Keys to check the computer and the spraying phases

Par.13.2.2 Operating switches for control unit valves

Par.13.2.3 Operating switches for hydraulic valves

Par.13.1 Display

14.4 Automatic closure of the main valve (through SKIPPER)

BRAVO 180S can automatically switch off main valve through SKIPPER: the navigator can autonomously manage valve opening and closing, thus preventing the overlapping of already-sprayed areas.

To use the automatic closure, connect SKIPPER to BRAVO 180S and carry out the **AUTOMATIC** operation procedure (par. 14.3.1); for further information, refer to the user's manual supplied with the SKIPPER satellite navigator.



WARNING: automatic closing is NOT active during manual operation.



14.5 Output menu

This menu contains the description of the functions available during the treatment.

A sub-menu is available for almost all data; to gain access to it press keys ▲ and ▼ at the same time for 1 second.

• Instantaneous speed indication

300 l/ha
Speed

Fig. 83



Speed simul.
Yes



The driving speed simulation allows spraying the product even without a speed sensor installed on the wheels.

The simulation is set to 6 km/h and can be varied by keeping K key pressed and pressing keys ▲ and ▼.

With this function the application rate can not be the real one since the speed can not be detected.

• Pressure indication

300 l/ha
Pressure

Fig. 84



Reset?
0.2 bar



Activate the "zero" calibration procedure of pressure sensor.

In case a pressure value is displayed **despite the absence of pressure inside the circuit**, it is necessary to perform zero setup of the sensor.

- Press K to reset the pressure sensor residual signal.

! Check sensor!

Faulty pressure values detected: check the transducer operation. If problem persists, check for residual pressure in the system.

• Instantaneous rate indication

300 l/ha
Flow

Fig. 85



• Covered area count

300 l/ha
Area

Fig. 86



• Sprayed fluid count

300 l/ha
Sprayed qty

Fig. 87



• Tank level*

300 l/ha
Tank level

Fig. 88



Tank level
01



It accesses the tank filling function (par. 14.5.1).

• Operation time calculation*

300 l/ha
Time

Fig. 89



• Traveled distance count*

300 l/ha
Distance

Fig. 90



* This menu item is displayed only if the EXTENDED view mode of the spraying menu is selected (par. 11.17).



14.5.1 Tank filling



Fig. 91

- 1** From the Spraying Menu, press until selecting Tank level.
- 2** Press the keys at the same time to access the tank filling procedure.

The filling will be managed in different ways according to the mode preset in the menu Tank source (par. 11.15).

- Possible options:
- Manual (**3a**)
 - Level Sensor (**3b**)

TANK LEVEL - MANUAL MODE



Fig. 92

From point **2** pass to menu Tank filling
BRAVO 180S displays the tank capacity: the value has been set in advanced setup.

- 3a** Set the real quantity of fluid filled in the tank.
- 4a** Press K to confirm the data.

It is not possible to set values higher than tank total capacity.

TANK LEVEL - LEVEL SENSOR MODE



Fig. 93

From point **2** pass to screen Tank level.

- 3b** Press to scroll through the items:

Tank level
BRAVO 180S displays the real quantity of fluid inside the tank, detected by the level sensor.

Filled qty
Start the filling pump and stop it at the end of the filling procedure.
When the level sensor is connected, the display shows the filling data in real time.



15 MAINTENANCE / DIAGNOSTICS / REPAIRS

15.1 Operation errors

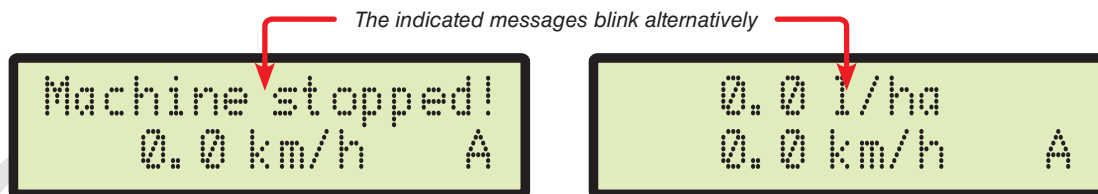

Fig. 94

Par.	JOB MODE	MESSAGE ON DISPLAY / CAUSE	REMEDY
13.2.2	MAN. + AUTO	Disable Main Main switch ON upon computer switching on	<ul style="list-style-type: none"> • Move main switch downwards (position OFF).
13.2.2 14.3.1	AUTO	Machine stopped! Main switch ON with machine stopped	<ul style="list-style-type: none"> • Start the farming machine. • Move main switch downwards (position OFF).
14.3.1	AUTO	Missing flow! Main switch ON with machine stopped but rate at zero	<ul style="list-style-type: none"> • Start the pump and move the farming machine.
11.9 14.3.1	AUTO	Slow down! The rate does not reach the value required for output	<ul style="list-style-type: none"> • Decrease the farming machine speed. • Check that the flowmeter constant value has been set correctly.
11.9 14.3.1	AUTO	Accelerate! The flowrate exceeds the value required for output	<ul style="list-style-type: none"> • Increase the farming machine speed. • Check that the flowmeter constant value has been set correctly.
11.11 14.5	MAN. + AUTO	Check sensor! Faulty pressure values have been detected	<ul style="list-style-type: none"> • Check the pressure sensor status and make sure there is no residual pressure in the system.
7.2 11.16	MAN. + AUTO	USB not found The pendrive is not inserted correctly	<ul style="list-style-type: none"> • Turn off the computer and check the insertion of the pendrive.
--	MAN. + AUTO	Error! <ul style="list-style-type: none"> • The pendrive is blocked • The pendrive has not free space 	<ul style="list-style-type: none"> • Switch off the computer and release the pendrive. • Space needed for new information: delete the unnecessary files from the pendrive.
12.11	MAN. + AUTO	File not found (SETUP.BIN) The computer configuration has not been saved	<ul style="list-style-type: none"> • Save the data.
11.16	MAN. + AUTO	File not found (TANK.TKL) The tank configuration has not been saved	<ul style="list-style-type: none"> • Save the data.
11.16 12.11	MAN. + AUTO	Wrong file <ul style="list-style-type: none"> • The file relevant to the computer configuration (SETUP.BIN) is faulty. • The file relevant to the tank configuration (TANK.TKL) is faulty. 	<ul style="list-style-type: none"> • Try to save the data again.
7.1 7.2	MAN. + AUTO	GPS timeout <ul style="list-style-type: none"> • Wrong cable connection for receiver • The receiver connection cable is damaged • The receiver is damaged 	<ul style="list-style-type: none"> • Check connection to receiver. • Replace the cable. • Replace the receiver.



15.2 Troubleshooting

FAULT	CAUSE	REMEDY
The display does not switch on	No power supply Computer is OFF	<ul style="list-style-type: none"> • Check power supply connection (par. 8.2). • Press the ON key.
Valve controls take no effect	Valves not connected	<ul style="list-style-type: none"> • Connect the connectors (par. 9.2).
One valve does not open	No power supply to valve	<ul style="list-style-type: none"> • Check valve electric connection and operation.
The display no longer shows the speed	Wrong setup	<ul style="list-style-type: none"> • Check the setup of the wheel constant (par. 11.7).
	No signal coming from the speed sensor	<ul style="list-style-type: none"> • Check connections to speed sensor (par. 9.4).
The displayed speed is not precise	Wrong setup	<ul style="list-style-type: none"> • Check the setup of the wheel constant (par. 11.7).
Output volume readout inaccurate	Wrong setup	<ul style="list-style-type: none"> • Check the setup of the boom width (par.11.5). • Check the setup of the flowmeter constant (par. 11.9). • Check the setup of the wheel constant (par. 11.7). • Check the setup of the section valve type (par. 11.8). • Check connections to speed sensor (par. 9.4).
Covered area count displayed does not match actual distance covered	Wrong setup	<ul style="list-style-type: none"> • Check the setup of the boom width (par. 11.5). • Check the setup of the wheel constant (par. 11.7). • Check connections to speed sensor (par. 9.4).
	The totalizer has not been reset	<ul style="list-style-type: none"> • Reset the totalizer (par. 14.2).
Distance traveled count displayed does not match actual distance covered	Wrong setup	<ul style="list-style-type: none"> • Check the setup of the wheel constant (par. 11.7). • Check connections to speed sensor (par. 9.4).
	The totalizer has not been reset	<ul style="list-style-type: none"> • Reset the totalizer (par. 14.2).
Sprayed fluid count displayed does not match litres/gpm actually sprayed	Wrong setup	<ul style="list-style-type: none"> • Check the setup of the flowmeter constant (par. 11.9). • Check the setup of the section valve type (par. 11.8).
	Use of three-way section valves without setting calibrated backflows	<ul style="list-style-type: none"> • Perform setting.
	The totalizer has not been reset	<ul style="list-style-type: none"> • Reset the totalizer (par. 14.2).
Unable to reach output volume value set for the automatic operation	Wrong setup	<ul style="list-style-type: none"> • Check application rate setup (par. 12.1). • Check the setup of the boom width (par. 11.5).
	System not adequately sized to provide required rate	<ul style="list-style-type: none"> • Check maximum pressure valve adjustment. • Make sure control valve is adequate for specific system.
	Control valve malfunction	<ul style="list-style-type: none"> • Check valve operation.
Instantaneous pressure readout inaccurate	Wrong setup	<ul style="list-style-type: none"> • Check full scale setup for pressure sensor (par. 11.11). • Check the settings of the nozzles being used (par. 12.1 - 11.14 - 11.5).
	Pressure sensor not calibrated	<ul style="list-style-type: none"> • Perform the calibration (par. 14.5).
	Pressure sensor wrong installation	<ul style="list-style-type: none"> • Check connections to pressure sensor (par. 9.4).
Instantaneous pressure is not displayed	Wrong setup	<ul style="list-style-type: none"> • Check pressure sensor setting (par. 11.11).
	Computer does not receive signals from pressure sensor	<ul style="list-style-type: none"> • Check connections to pressure sensor (par. 9.4).
	Pressure sensor wrong installation	<ul style="list-style-type: none"> • Check connections to pressure sensor (par. 9.4).
The displayed tank level is not precise	Level sensor not calibrated	<ul style="list-style-type: none"> • Perform the calibration (par. 11.16). • Calibrate the level sensor again (par. 11.16).
	Level sensor wrong installation	<ul style="list-style-type: none"> • Check connections to level sensor (par. 9.4).
During the tank calibration procedure, the sprayed quantity is always steady on zero	Wrong installation / no flowmeter installed.	<ul style="list-style-type: none"> • Check connections to the flowmeter (par. 9.4). • Install the flowmeter (par. 7.1).
	Section valves and main control valve set to OFF .	<ul style="list-style-type: none"> • Take section valves and main control valve to ON (par. 13.2.2).

15.3 Cleaning rules

- Clean only with a soft wet cloth.
- DO NOT use aggressive detergents or products.
- DO NOT clean equipment with direct water jets.



16 TECHNICAL DATA

• Advanced menu

Data	Description	Min.	Max.	UoM	DEFAULT	Other values that can be set / Notes	
Language	Display language	--	--	--	English	English, Italian, Spanish, Portuguese, French, German, Polish, Croatian, Hungarian, Greek, Russian, Turkish, Czech, US, US TURF	
Units of measur.	Display unit of measurement	--	--	--	EU	US, US TURF	
No. of sections	Number of section valves in the system	1	7	--	5	--	
Total boom width	Section 1 ÷ 7	0.00	30.00	m	4.00	To view this value it is necessary to set the width of each boom section	
		0.0	100.0	ft	13.1		
Variable rate	Application rate regulation carried out through Skipper	--	--	--	No	Yes	
Speed sensor	Wheel	Disabled	99.99	EU: cm/pls	50.00	Number of constant to be set: 1 ÷ 3 Includes the sub-menus: Manual setup, Automatic calc.	
	GPS source		99.99	US - TURF: in/pls	19.68		
Valves	Section valves	--	--	--	3-Ways	2-Ways	
	Sections manag.	--	--	--	Manual (P Mode)	Auto (M Mode)	
	Regulation	--	--	--	3-Ways	2-Ways	
	Main	--	--	--	3-Ways	2-Ways	
Flowmeter	Orion	--	--	--	--	Data necessary to calculate the rate	
	Altro...	--	--	--	--		
Flowmeter constant	Constant	Disabled	30000	EU: pls/l	600	Data necessary to calculate the rate	
				US - TURF: pls/gal	2271		
Pressure sensor	Data necessary to determine the instantaneous pressure	Disabled	1000.0	EU: bar	Disabled	--	
			14500	US - TURF: PSI			
Flow calculation*	Sensor used to calculate the output	--	--	--	Flowmeter	Pressure sensor * Only if the pressure sensor is enabled	
Press. calc.	Enabling/disabling the pressure calculation	--	--	--	No	Yes	
Nozzle qty*	Number of nozzles on the boom	1	1000	--	40	* Only if "Yes" is set in the previous item (Pressure calc.).	
Tank source	The active option affects the entire configuration of the Setup Cisterna	--	--	--	Manual	Level Sensor	
Tank settings	Manual	Tank volume	1	20000	EU: l	1000	Below this value the computer triggers an acoustic and visual alarm
		Tank reserve	1	5500	US - TURF: gal	264	
			No	1000	EU: l	50	
			264	US - TURF: gal	13		
Spraying Menu	Allows selecting whether to view the totalizers	--	--	--	Large	Short	

pls = pulse
turn = turn

• User menu

Data	Description	Min.	Max.	UoM	DEFAULT	Other values that can be set / Notes
Jobs setup	Select a job that can be set	1	10	--	--	--
	Rate Type	--	--	--	Constant	Variable, Disabled
	Target rate	Off	6000	EU: l/ha	--	--
				US - TURF: GPA	600	
Nozzle type	--	--	--	--	ISO	USR A ÷ E
Nozzle data	Nozzles type	--	--	--	--	Selection of nozzle to be set: ISO, USR
		Flow	0.01	99.99	EU: l/min	
	Pressure	0.001	99.999	US - TURF: GPM	0.264	Value that can be modified ONLY for customised nozzles
		0.00	999.9	EU : bar	3.0	
		0	9999	US - TURF: PSI	44	
Min. reg. press.	Minimum pressure for automatic regulation block	Disabled	100.0	EU: bar	Disabled	--
			1450	US - TURF: PSI		
Wheel selection	Selection of pre-set wheel	1	3	--	--	--
Minimum speed	Below this set value the computer interrupts the spraying	Disabled	99.9	EU: km/h	Disabled	--
			99.9	US - TURF: MPH		
Rate correction	Fluid density factor	0.01	10.0	--	1.00	--
Level correction	Fluid weight	0.01	100.00	EU: kg/l	1.00	--
			1000.00	US - TURF: oz/gal	133.53	
Display contrast	Contrast adjustment	0	100	%	50	--



• Output values

Data	Min.	Max.	UoM	Description	Notes
Volume applied	0	99999	EU: l/ha	Quantity of sprayed fluid for unit of surface	Shown on the first line of the display, during treatment
	0.0	99999,9	US: GPA		
	0.00	99999,99	US TURF: GPK		
Speed	0.0	199,9	EU: km/h	Vehicle driving speed	--
	0.0	199,9	US - US TURF: MPH		
Pressure	0.0	999,9	EU: bar	Output pressure	Present only if YES has been set in the advanced menu "Pressure calculation"
	0	9999	US: PSI		
Flow	0.0	999,9	EU: l/min	Fluid sprayed per time unit	Fluid actually sprayed by the nozzles
	0.0	999,9	US - US TURF: GPM		
Area	0.000	999999	EU: ha	Sprayed surface	Floating point The totalizer increases when the main switch is ON
	0.000	999999	US: acres		
	0.000	999999	US TURF: 1000 square ft		
Sprayed qty	0	999999	EU: l	Sprayed fluid	The totalizer increases when the main switch is ON
	0	999999	US - US TURF: gal		
Tank level	0	20000	EU: l	Remaining fluid in the tank	Floating point The totalizer decreases when the main switch is ON
	0	5500	US - US TURF: gal		
Time	00:00	10000	EU - US - US TURF: h	Treatment time	Floating point The totalizer increases when the main switch is ON From 00:01 to 99:59 the format is hh:mm
Distance	0.000	99999	EU: km	Traveled distance	Floating point The totalizer increases when the main switch is OFF
	0.000	99999	US - US TURF: miles		

16.1 Computer technical data

Description	
Display	Alphanumeric LCD 2 lines x 16 characters, backlit
Power supply voltage	11 ÷ 14 Vdc
Consumption (valves excluded)	150 mA
Operating temperature	0°C ÷ 60 °C +32°F ÷ +140 °F
Digital inputs	for open collector sensors: max 2000 imp/s
Weight	800 g - Bravo without hydraulic controls 1140 g - Bravo with hydraulic controls (without harness)
Protection against polarity inversion	•
Protection against short-circuit	•



17 END OF LIFE DISPOSAL

Dispose of the system in compliance with the established legislation in the country of use.

18 GUARANTEE TERMS

1. ARAG s.r.l. guarantees this apparatus for a period of 360 days (1 year) from the date of sale to the client user (date of the goods delivery note).
The components of the apparatus, that in the unappealable opinion of ARAG are faulty due to an original defect in the material or production process, will be repaired or replaced free of charge at the nearest Assistance Center operating at the moment the request for intervention is made. The following costs are excluded:
 - disassembly and reassembly of the apparatus from the original system;
 - transport of the apparatus to the Assistance Center.
2. The following are not covered by the guarantee:
 - damage caused by transport (scratches, dents and similar);
 - damage due to incorrect installation or to faults originating from insufficient or inadequate characteristics of the electrical system, or to alterations resulting from environmental, climatic or other conditions;
 - damage due to the use of unsuitable chemical products, for spraying, watering, weedkilling or any other crop treatment, that may damage the apparatus;
 - malfunctioning caused by negligence, mishandling, lack of know how, repairs or modifications carried out by unauthorized personnel;
 - incorrect installation and regulation;
 - damage or malfunction caused by the lack of ordinary maintenance, such as cleaning of filters, nozzles, etc.;
 - anything that can be considered to be normal wear and tear.
3. Repairing the apparatus will be carried out within time limits compatible with the organizational needs of the Assistance Center. No guarantee conditions will be recognized for those units or components that have not been previously washed and cleaned to remove residue of the products used.
4. Repairs carried out under guarantee are guaranteed for one year (360 days) from the replacement or repair date.
5. ARAG will not recognize any further expressed or intended guarantees, apart from those listed here.
No representative or retailer is authorized to take on any other responsibility relative to ARAG products.
The period of the guarantees recognized by law, including the commercial guarantees and allowances for special purposes are limited, in length of time, to the validities given here.
In no case will ARAG recognize loss of profits, either direct, indirect, special or subsequent to any damage.
6. The parts replaced under guarantee remain the property of ARAG.
7. All safety information present in the sales documents regarding limits in use, performance and product characteristics must be transferred to the end user as a responsibility of the purchaser.
8. Any controversy must be presented to the Reggio Emilia Law Court.

Cleveland Alliances
01361883418

Cleveland Alliances
01361883418

Conformity Declaration



ARAG s.r.l.
Via Palladio, 5/A
42048 Rubiera (RE) - Italy
P.IVA 01801480359

Dichiara

che il prodotto
descrizione: **Computer**

modello: **Bravo 180S**
serie: **46718xxxx**

risponde ai requisiti di conformità contemplati nelle seguenti Direttive Europee:
2004/108/CE
(Compatibilità Elettromagnetica)

Riferimenti alle Norme Applicate:
UNI EN ISO 14982
(Macchine agricole e forestali - Compatibilità elettromagnetica
Metodi di prova e criteri di accettazione)

Rubiera, 22 aprile 2013

Giovanni Montorsi

A handwritten signature in black ink, appearing to read "Montorsi", is written over a horizontal line.

(Presidente)

Only use genuine ARAG accessories or spare parts to make sure manufacturer guaranteed safety conditions are maintained in time. Always refer to ARAG spare parts catalogue.

Cleveland Alliances
01361883418

D20272_GB-m03 03/2015



42048 RUBIERA (Reggio Emilia) - ITALY
Via Palladio, 5/A

Tel. +39 0522 622011
Fax +39 0522 628944

www.aragnet.com
info@aragnet.com